



# Panasonic®

## OPERATING INSTRUCTIONS

Personal Computer

Model No. **CF-53** series

### Contents

#### Read Me First

Safety Precautions .....	2
Regulatory Information .....	6

#### Getting Started

Introduction.....	11
Description of Parts .....	12
First-time Operation.....	14
Turning On / Turning Off.....	19

#### Useful Information

On-screen Manual.....	20
Handling and Maintenance.....	21
Installing Software .....	23

#### Troubleshooting

Troubleshooting (Basic).....	27
------------------------------	----

#### Appendix

LIMITED USE LICENSE AGREEMENT .....	32
Specifications .....	33
Standard Limited Warranty .....	37

Read Me First

Getting Started

Useful Information

Troubleshooting

Appendix

Please read these instructions carefully before using this product, and save this manual for future use.

# Safety Precautions

To reduce the risk of injury, loss of life, electric shock, fire, malfunction, and damage to equipment or property, always observe the following safety precautions.

## Explanation of symbol word panels

The following symbol word panels are used to classify and describe the level of hazard, injury, and property damage caused when the denotation is disregarded and improper use is performed.

### DANGER

Denotes a potential hazard that will result in serious injury or death.

### WARNING

Denotes a potential hazard that could result in serious injury or death.



### CAUTION

Denotes a hazard that could result in minor injury.

### NOTICE

Denotes a hazard that could result in property damage.

The following symbols are used to classify and describe the type of instructions to be observed.

	These symbols are used to alert users to a specific operating procedure that must not be performed.
	This symbol is used to alert users to a specific operating procedure that must be followed in order to operate the unit safely.

## DANGER

Electrolyte leakage, generation of heat, ignition or rupture of the Battery Pack may result.



- Do Not Throw the Battery Pack into a Fire or Expose It to Excessive Heat
- Do Not Insert Sharp Objects Into the Battery Pack, Disassemble, or Modify It
- Do Not Short the Positive (+) and Negative (-) Contacts
  - ⇒ Do not place the battery pack together with articles such as necklaces or hairpins when carrying or storing.
- Do Not Apply Shocks to the Product by Dropping It, Applying Strong Pressure to It, etc.
  - ⇒ If this product is subjected to a strong impact, damaged or deformed, stop using it immediately.
- Do Not Charge the Battery Using Methods Other Than Those Specified
- Do Not Use the Battery Pack with Any Other Product
  - The battery pack is rechargeable and was intended for the specified product.
- Do Not Use This Product with a Battery Pack Other Than the One Specified
  - ⇒ Use only the specified battery pack with your product.



- Avoid Extreme Heat (Near the Fire, in Direct Sunlight, for Example)
- When the Battery Pack Has Deteriorated, Replace It With a New One
  - ⇒ Do not continue to use a damaged battery pack.

## **WARNING**

**Fire or electric shock may result.**



- **Do Not Do Anything That May Damage the AC Cord, the AC Plug, or the AC Adaptor**  
Do not damage or modify the cord, place it near hot tools, bend, twist, or pull it forcefully, place heavy objects on it, or bundle it tightly.  
⇒ Do not continue to use a damaged AC cord, AC plug and AC adaptor.
  - Contact your technical support office for repair.
- **Do Not Connect the AC Adaptor to a Power Source Other Than a Standard Household AC Outlet**  
⇒ Connecting to a DC/AC converter (inverter) may damage the AC adaptor. On an airplane, only connect the AC adaptor/charger to an AC outlet specifically approved for such use.
- **Do Not Pull or Insert the AC Plug If Your Hands Are Wet**
- **Do Not Disassemble This Product**
- **Do Not Touch This Product In a Thunderstorm If Connected with the AC Cable or Any Other Cables**



- **If a Malfunction or Trouble Occurs, Immediately Stop Use**  
If the Following Malfunction Occurs, Immediately Unplug the AC Plug (and the Battery Pack)
  - This product is damaged
  - Foreign object inside this product
  - Smoke emitted
  - Unusual smell emitted
  - Unusually hot
 ⇒ After the above procedure, contact your technical support office for repair.
- **Clean Dust and Other Debris of the AC Plug Regularly**
  - If dust or other debris accumulates on the plug, humidity, etc. may cause a defect in the insulation.
- **Insert the AC Plug Completely**  
⇒ Do not use a damaged plug or loose AC outlet.
- **Close the Connector Cover Tightly When Using This Product Where Is a Lot of Water, Moisture, Steam, Dust, Oily Vapors, etc.**  
⇒ If foreign matter has found its way inside, immediately turn the power off and unplug the AC cord, and then remove the battery pack. Then contact your technical support office.

**Burns or low-temperature burns may result.**



- **Do Not Use This Product in Close Contact With Your Body For a Long Period of Time**  
⇒ Do not use this product with its heat-emitting parts in close contact with your body for long periods of time.
  - Low-temperature burns may result.
- **Do Not Expose Yourself or Other Persons to the Hot Wind from the Ventilation Hole (Exhaust) For a Long Period of Time.**
  - Covering the ventilation hole (exhaust) with your hand or other object can cause heat to build up inside, possibly resulting in burns.
- **Do Not Touch The Surface of The AC Adaptor Continuously While Using/Charging**
  - Burns may result.

**Detrimental health effects on your body may result.**



- **Do Not Turn the Volume Up To Loud When Using Headphones**
  - Listening at high volumes that overstimulate the ear for long periods of time may result in loss of hearing.

## **CAUTION**

**Fire or electric shock may result.**



- **Do Not Move This Product While the AC Plug Is Connected**  
⇒ If the AC cord is damaged, unplug the AC plug immediately.
- **Do Not Connect a Telephone Line, or a Network Cable Other Than the One Specified, Into the LAN Port**  
⇒ Do not connect to a network such as the ones listed below.
  - Networks other than 1000BASE-T, 100BASE-TX or 10BASE-T
  - Phone lines (IP phone (Internet Protocol Telephone), Telephone lines, internal phone lines (on-premise switches), digital public phones, etc.)
- **Do Not Subject the AC Adaptor To Any Strong Impact**  
⇒ Do not continue to use the AC adaptor after a strong impact such as being dropped.  
⇒ Contact your technical support office for repair.
- **Do Not Leave This Product in High Temperature Environment for a Long Period of Time**
  - Leaving this product where it will be exposed to extremely high temperatures such as near fire or in direct sunlight may deform the cabinet and/or cause trouble in the internal parts.
- **Do Not Block the Ventilation Hole (Exhaust/Intake)**  
⇒ Do not use this product wrapped in cloth or on top of bedding or a blanket.

# Safety Precautions

## CAUTION

### Fire or electric shock may result.



- **Hold the Plug When Unplugging the AC Plug**
- **Use Only the Specified AC Adaptor With This Product**
  - ⇒ Do not use an AC adaptor other than the one supplied (supplied with the unit or one sold separately as an accessory).
- **Use the Modem With a Regular Telephone Line**
  - ⇒ Do not connect to the following lines.
    - An internal phone line (on-premise switches) of a company or business office
    - A digital public phone
    - Line in a country or area not supported by this product.

### This product may fall over or drop, resulting in an injury.



- **Do Not Place This Product on Unstable Surfaces**



- **Avoid Stacking**

### Detrimental health effects on your body may result.



- **Do Not Look Into the CD/DVD Drive**
  - Looking directly at the internal laser light source may result in damage to eyesight.
  - ⇒ Contact your technical support office for check, maintenance and repair.
- **Do Not Use Discs That Are Cracked or Deformed**
  - Because the discs rotate at high speeds, damaged discs may break apart causing injury.
  - ⇒ Discs that are not round and discs that have been repaired using adhesives are similarly dangerous, and so should not be used.



- **Take a Break Of 10-15 Minutes Every Hour**
  - Using this product for long periods of time may have detrimental health effects on the eyes or hands.

### Burns, low-temperature burns, or frostbite may result.



- **Do Not Expose the Skin To This Product When Using the Product In A Hot Or Cold Environment.**
  - ⇒ When it is necessary to expose the skin to this product such as to scan a fingerprint, perform the operation in the shortest time possible.

## NOTICE

- Do not place the computer near a television or radio receiver.
- Keep the computer away from magnets. Data stored on the hard disk may be lost.
- Do not touch the terminals on the battery pack. The battery pack may no longer function properly if the contacts are dirty or damaged.
- Do not expose the battery pack to water, or allow it to become wet.
- If the battery pack will not be used for a long period of time (a month or more), charge or discharge (use) the battery pack until the remaining battery level becomes 30% to 40% and store it in a cool, dry place.
- This computer prevents overcharging of the battery by recharging only when the remaining power is less than approx. 95% of capacity.
- The battery pack is not charged when the computer is first purchased. Be sure to charge it before using it for the first time. When the AC adaptor is connected to the computer, charging begins automatically.
- Should the battery leak and the fluid get into your eyes, do not rub your eyes. Immediately flush your eyes with clear water and see a doctor for medical treatment as soon as possible.

THIS PRODUCT IS NOT INTENDED FOR USE AS, OR AS PART OF, NUCLEAR EQUIPMENT/SYSTEMS, AIR TRAFFIC CONTROL EQUIPMENT/SYSTEMS, AIRCRAFT COCKPIT EQUIPMENT/SYSTEMS, MEDICAL DEVICES OR ACCESSORIES<sup>1)</sup>, LIFE SUPPORT SYSTEMS OR OTHER EQUIPMENTS/DEVICES/SYSTEMS THAT ARE INVOLVED WITH ENSURING HUMAN LIFE OR SAFETY. PANASONIC WILL NOT BE RESPONSIBLE FOR ANY LIABILITY RESULTING FROM THE USE OF THIS PRODUCT ARISING OUT OF THE FOREGOING USES.

<sup>1)</sup> As defined by the European Medical Device Directive (MDD) 93/42/EEC.



Panasonic cannot guarantee any specifications, technologies, reliability, safety (e.g. Flammability/Smoke/Toxicity/Radio Frequency Emission, etc) requirements related to aviation standards and medical equipment standards that differ from the specifications of our COTS (Commercial-Off-The-Shelf) products.

Panasonic cannot guarantee any specifications, technologies, reliability, safety (e.g. Flammability/Smoke/Toxicity/Radio Frequency Emission, etc) requirements related to aviation standards that exceed the specifications of our COTS (Commercial-Off-The-Shelf) products.

This computer is not intended for use in medical equipment including life-support systems, air traffic control systems, or other equipment, devices or systems that are involved with ensuring human life or safety. Panasonic cannot be held responsible in any way for any damages or loss resulting from the use of this unit in these types of equipment, devices or systems, etc. This computer has been designed so as to minimize shock to the LCD and hard disk drive, the leakage of liquid (e.g., water) on to the keyboard, etc., but no warranty is provided against such trouble. Therefore, as a precision instrument, be extremely careful in the handling.

---

**NOTE**

- The battery pack may become warm during recharging or normal use. This is completely normal.
  - Recharging will not commence if internal temperature of the battery pack is outside of the allowable temperature range (0 °C to 50 °C).  
(→  *Reference Manual* “Battery Power”) Once the allowable range requirement is satisfied, charging begins automatically. Note that the recharging time varies based on the usage conditions. (Recharging takes longer than usual when the temperature is 10 °C or below.)
  - If the temperature is low, the operating time is shortened. Only use the computer within the allowable temperature range.
  - This computer has a high temperature mode function that prevents the degradation of the battery in high temperature environments. (→  *Reference Manual* “Battery Power”) A level corresponding to a 100% charge for high temperature mode is approximately equivalent to an 80% charge level for normal temperature mode.
  - The battery pack is a consumable item. If the amount of time the computer can be run by using a particular battery pack becomes dramatically shorter and repeated recharging does not restore its performance, the battery pack should be replaced with a new one.
  - When transporting a spare battery inside a package, briefcase, etc., it is recommended that it be placed in a plastic bag so that its contacts are protected.
  - Always power off the computer when it is not in use. Leaving the computer on when the AC adaptor is not connected will exhaust the remaining battery capacity.
-

# Regulatory Information

## Important Safety Instructions

<Only for model with modem>

When using your telephone equipment, basic safety precautions should always be followed to reduce the risk of fire, electric shock and injury to persons, including the following:

1. Do not use this product near water, for example, near a bath tub, wash bowl, kitchen sink or laundry tub, in a wet basement or near a swimming pool.
2. Avoid using a telephone (other than a cordless type) during an electrical storm. There may be a remote risk of electric shock from lightning.

3. Do not use the telephone to report a gas leak in the vicinity of the leak.
4. Use only the power cord and batteries indicated in this manual. Do not dispose of batteries in a fire. They may explode. Check with local codes for possible special disposal instructions.

SAVE THESE INSTRUCTIONS

19-E-1

## Information to the User

<Only for model with wireless LAN/Bluetooth>

### This product and your Health

This product, like other radio devices, emits radio frequency electromagnetic energy. The level of energy emitted by this product however is far much less than the electromagnetic energy emitted by wireless devices like for example mobile phones.

Because this product operates within the guidelines found in radio frequency safety standards and recommendations, we believe this product is safe for use by consumers. These standards and recommendations reflect the consensus of the scientific community and result from deliberations of panels and committees of scientists who continually review and interpret the extensive research literature.

In some situations or environments, the use of this product may be restricted by the proprietor of the building or responsible representatives of the organization. These situations may for example include:

- Using this product on board of airplanes, or
- In any other environment where the risk of interference to other devices or services is perceived or identified as harmful.

If you are uncertain of the policy that applies on the use of wireless devices in a specific organization or environment (e.g. airports), you are encouraged to ask for authorization to use this product prior to turning on the product.

### Regulatory Information

We are not responsible for any radio or television interference caused by unauthorized modification of this product. The correction of interference caused by such unauthorized modification will be the responsibility of the user. We and its authorized resellers or distributors are not liable for damage or violation of government regulations that may arise from failing to comply with these guidelines.

26-M-1

## Regulations for Wireless LAN / Bluetooth

Country / Region	802.11a	802.11b/g Bluetooth
Austria, Belgium, Croatia, Cyprus, Czech Republic, Denmark, Estonia, Finland, Germany, Greece, Hungary, Iceland, Ireland, Latvia, Lithuania, Macedonia, Malta, Netherlands, Poland, Portugal, Slovakia, Slovenia, Spain, Sweden, Switzerland, United Kingdom	Restricted to indoor use.	
France	Restricted to indoor use.	
Italy	Restricted to indoor use. General authorization required if used outside.	General authorization required if used outside of own premises.
Luxembourg	Restricted to indoor use. General authorization required for public service.	General authorization required for public service.
Turkey	Restricted to indoor use. Prohibited within an 1 km radius from the centre of the runway of the airports.	
Norway	Restricted to indoor use.	Prohibited within a 20 km radius from the centre of Ny-Ålesund.



- The latest version of “ERC RECOMMENDATION 70-03” by European Radiocommunications Committee and the regulation in Turkey.
- Use only the antenna specified by Panasonic.
- Confirm the latest information to the radio regulation authorities.

40-E-1

## Safety Precautions

<Only for model with wireless WAN>

The following safety precautions must be observed during all phases of the operation, usage, service or repair of any Personal Computer or Handheld Computer incorporating wireless WAN modem. Manufacturers of the cellular terminal are advised to convey the following safety information to users and operating personnel and to incorporate these guidelines into all manuals supplied with the product. Failure to comply with these precautions violates safety standards of design, manufacture and intended use of the product. Panasonic assumes no liability for customer failure to comply with these precautions.



When in a hospital or other health care facility, observe the restrictions on the use of mobiles. Switch Personal Computer or Handheld Computer incorporating wireless WAN modem off, if instructed to do so by the guidelines posted in sensitive areas. Medical equipment may be sensitive to RF energy. The operation of cardiac pacemakers, other implanted medical equipment and hearing aids can be affected by interference from Personal Computer or Handheld Computer incorporating wireless WAN modem placed close to the device. If in doubt about potential danger, contact the physician or the manufacturer of the device to verify that the equipment is properly shielded. Pacemaker patients are advised to keep their Personal Computer or Handheld Computer incorporating wireless WAN modem away from the pacemaker, while it is on.



Switch off Personal Computer or Handheld Computer incorporating wireless WAN modem before boarding an aircraft. Make sure it cannot be switched on inadvertently. The operation of wireless appliances in an aircraft is forbidden to prevent interference with communications systems. Failure to observe these instructions may lead to the suspension or denial of cellular services to the offender, legal action, or both. For details on usage of this unit in aircrafts please consult and follow instruction provided by the airline.



Do not operate Personal Computer or Handheld Computer incorporating wireless WAN modem in the presence of flammable gases or fumes. Switch off the cellular terminal when you are near petrol stations, fuel depots, chemical plants or where blasting operations are in progress. Operation of any electrical equipment in potentially explosive atmospheres can constitute a safety hazard.



Your Personal Computer or Handheld Computer incorporating wireless WAN modem receives and transmits radio frequency energy while switched on. Remember that interference can occur if it is used close to TV sets, radios, computers or inadequately shielded equipment. Follow any special regulations and always switch off Personal Computer or Handheld Computer incorporating wireless WAN modem wherever forbidden, or when you suspect that it may cause interference or danger.



Road safety comes first! Do not use a Personal Computer or Handheld Computer incorporating wireless WAN modem while driving a vehicle. Do not place the computer with wireless WAN modem in an area where it could cause personal injury to the driver or passengers. It is recommended to stow the unit in the boot or secure stowage area while driving.

Do not place the computer with wireless WAN modem in an area over an air bag or in the vicinity where an air bag may deploy.

Air bags inflate with great force and if the computer with wireless WAN modem is placed in the air bag deployment area may be propelled with great force and cause serious injury to occupants of the vehicle.



**IMPORTANT!**

Personal Computer or Handheld Computer incorporating wireless WAN modem operate using radio signals and cellular networks cannot be guaranteed to connect in all conditions. Therefore, you should never rely solely upon any wireless device for essential communications, for example emergency calls.

Remember, in order to make or receive calls, Personal Computer or Handheld Computer incorporating wireless WAN modem must be switched on and in a coverage area with adequate cellular signal strength.

Some networks do not allow for emergency calls if certain network services or phone features are in use (e.g. lock functions, fixed dialing etc.). You may need to deactivate those features before you can make an emergency call.

Some networks require that a valid SIM card be properly inserted in Personal Computer or Handheld Computer incorporating wireless WAN modem.

### Interface Cable

Use of an interface cable longer than 3 m is not recommended.

11-E-1

### CAUTION:

Risk of Explosion if Battery is replaced by an Incorrect Type. Dispose of Used Batteries According to the Instructions.

58-E-1

# Regulatory Information

## Lithium Battery

### Lithium Battery!

This computer contains a lithium battery to enable the date, time, and other data to be stored. The battery should only be exchanged by authorized service personnel.

Warning! A risk of explosion from incorrect installation or misapplication may possibly occur.

15-E-1

## For Used in Motor Vehicle

Warning: Check the following Commission Recommendation to determine proper installation and usage of this product while operating within a motor vehicle.

“Commission Recommendation on safe and efficient in-vehicle information and communication systems: A European statement of principles on human machine interface.”

Commission Recommendation is available from Official Journal of the European Communities.

35-E-1

## CD/DVD Drive Caution

### CAUTION!

THIS PRODUCT UTILIZES A LASER.  
USE OF CONTROLS, ADJUSTMENTS OR PERFORMANCE OF PROCEDURES OTHER THAN THOSE SPECIFIED HEREIN MAY RESULT IN HAZARDOUS RADIATION EXPOSURE.  
DO NOT OPEN COVERS AND DO NOT REPAIR YOURSELF.  
REFER SERVICING TO QUALIFIED PERSONNEL.

The following label is put on the bottom of the computer.



12-1-1

12-E-1

## Information for Users on Collection and Disposal of Old Equipment and used Batteries



These symbols on the products, packaging, and/or accompanying documents mean that used electrical and electronic products and batteries should not be mixed with general household waste.

For proper treatment, recovery and recycling of old products and used batteries, please take them to applicable collection points, in accordance with your national legislation and the Directives 2002/96/EC and 2006/66/EC.

By disposing of these products and batteries correctly, you will help to save valuable resources and prevent any potential negative effects on human health and the environment which could otherwise arise from inappropriate waste handling.

For more information about collection and recycling of old products and batteries, please contact your local municipality, your waste disposal service or the point of sale where you purchased the items.

Penalties may be applicable for incorrect disposal of this waste, in accordance with national legislation.



### For business users in the European Union

If you wish to discard electrical and electronic equipment, please contact your dealer or supplier for further information.

### [Information on Disposal in other Countries outside the European Union]

These symbols are only valid in the European Union. If you wish to discard this product, please contact your local authorities or dealer and ask for the correct method of disposal.



### Note for the battery symbol (bottom two symbol examples):

This symbol might be used in combination with a chemical symbol. In this case it complies with the requirement set by the Directive for the chemical involved.

53-E-1



## Models for Europe

<Only for model with a “CE Ⓢ” mark on the bottom of the computer>



### Declaration of Conformity (DoC)

“Hereby, Panasonic declares that this Personal Computer is in compliance with the essential requirements and other relevant provisions of the Directive 1999/5/EC.”

#### Hint:

If you want to get a copy of the original DoC of our above mentioned products, please contact our web address: <http://www.ptc.panasonic.eu>

Authorised Representative:

Panasonic Testing Centre  
Panasonic Marketing Europe GmbH  
Winsbergring 15, 22525 Hamburg, Germany

Network connection of Wired Modem.

The terminal equipment is intended for connection to the following public network;

In all the countries of European Economical Area and Turkey;

- Public Switched Telephony Networks

Technical Features of Wired Modem.

The terminal equipment includes the following features;

- DTMF dialing
- Maximum bitrate receiving mode: 56 kbit/s
- Maximum bitrate sending mode: 33.6 kbit/s

Indication of the countries where WLAN is intended to be used:

AT BE BG CH CY CZ DE DK EE ES  
FI FR GB GR HR HU IE IS IT LT LU  
LV MT NL NO PL PT RO SE SI SK TR

18-25-E-1

This equipment requires minimum 20 cm spacing from all person's body (excluding extremities of hands, wrist and feet) in directions of the back and both sides of the LCD display during wireless modes of operation. If you use this equipment in tablet mode when utilizing the wireless functionality, it requires a minimum 10 mm spacing from the body (excluding extremities such as hands, wrist and feet) around the left and right hand sides of the LCD display.

60-E-1

<Only for model with a “CE” mark on the bottom of the computer>



### Declaration of Conformity (DoC)

“Hereby, Panasonic declares that this Personal Computer is in compliance with the essential requirements and other relevant provisions of the Directive 1999/5/EC.”

#### Hint:

If you want to get a copy of the original DoC of our above mentioned products, please contact our web address: <http://www.ptc.panasonic.eu>

Authorised Representative:

Panasonic Testing Centre  
Panasonic Marketing Europe GmbH  
Winsbergring 15, 22525 Hamburg, Germany

Network connection of Wired Modem.

The terminal equipment is intended for connection to the following public network;

In all the countries of European Economical Area and Turkey;

- Public Switched Telephony Networks

Technical Features of Wired Modem.

The terminal equipment includes the following features;

- DTMF dialing
- Maximum bitrate receiving mode: 56 kbit/s
- Maximum bitrate sending mode: 33.6 kbit/s

18-E-1

# Regulatory Information

## Models for UK

For your safety, please read the following text carefully.

This appliance is supplied with a molded three pin mains plug for your safety and convenience. A 3 ampere fuse is fitted in this plug.

Should the fuse need to be replaced please ensure that the replacement fuse has a rating of 3 ampere and that it is approved by ASTA or BSI to BS1362.

Check for the ASTA mark  or the BSI mark  on the body of the fuse.

If the plug contains a removable fuse cover you must ensure that it is refitted when the fuse is replaced.

If you lose the fuse cover the plug must not be used until a replacement cover is obtained. A replacement fuse cover can be purchased from your local dealer.

If the fitted molded plug is unsuitable for the socket outlet in your home then the fuse should be removed and the plug cut off and disposed of safely.

There is a danger of severe electrical shock if the cut off plug is inserted into any 13-ampere socket.

### How to replace the fuse

The location of the fuse differs according to the type of AC mains plug (figures A and B).

Confirm the AC mains plug fitted and follow the instructions below. Illustrations may differ from actual AC mains plug.

Open the fuse cover with a screwdriver and replace the fuse and close or attach the fuse cover.

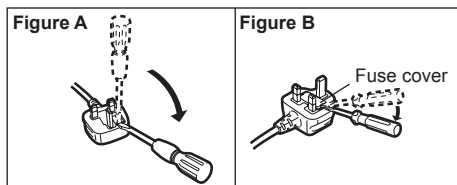

8-E-1

## Models for India



For the purpose of recycling to facilitate effective utilization of resources, please return this product to a nearby authorized collection center, registered dismantler or recycler, or Panasonic service center when disposing of this product.

Please see the Panasonic website for further information on collection centers, etc.

<http://www.panasonic.co.in/wps/portal/home>

68-M-1

## Models for Turkey

AEEE complies with Directive of Turkey.

66-M-1

AEEE Yönetmeliğine Uygundur.

66-Tr-1

# Introduction









Thank you for purchasing this Panasonic product. For optimum performance and safety, please read these instructions carefully.

In these instructions, the names are referred as follows.

**Windows 8** indicates Windows® 8 Operating System.

**Windows 7** indicates Windows® 7 Operating System.

## ■ Terms and illustrations in these instructions

<b>CAUTION</b> :	Conditions that may result in minor or moderate injury.
<b>NOTE</b> :	Useful and helpful information.
<b>Enter</b> :	Press [Enter] key.
<b>Fn + F5</b> :	Press and hold [Fn] key, and then press [F5] key.
<b>Windows 8</b>	
● Display “Charm”:	Align the cursor to the top right (or bottom right) corner of the screen to display Charm menu. Alternatively, flick toward the center of the screen from the right edge.
●  -  :	Click  (Settings) and then click  (Power).
<b>Windows 7</b>	
 (Start) - [All Programs] :	Click  (Start), and then click [All Programs]. You may need to double-click in some cases.
 :	Page in these Operating Instructions or in the Reference Manual.
 :	Reference to the on-screen manuals.

- Some illustrations are simplified to help your understanding and may look different from the actual unit.
- If you do not log on as an administrator, you cannot use some functions or cannot display some screens.
- Refer for the latest information about optional products to the catalogs, etc.
- In these instructions, the names and terms are referred as follows.
  - “Windows® 8 Pro 64-bit” as “Windows” or “Windows 8”
  - “Windows® 7 Professional 32-bit Service Pack 1” and “Windows® 7 Professional 64-bit Service Pack 1” as “Windows” or “Windows 7”
  - DVD MULTI drive as “CD/DVD drive”
  - Circular media including DVD-ROM and CD-ROM as “discs”
  - “Multilanguage User Interface” as “MUI”

## ■ Disclaimer

Computer specifications and manuals are subject to change without notice. Panasonic Corporation assumes no liability for damage incurred directly or indirectly from errors, omissions or discrepancies between the computer and the manuals.

## ■ Trademarks

Microsoft®, Windows® and the Windows logo are registered trademarks of Microsoft Corporation of the United States and/or other countries.

Intel, Core, Centrino and PROSet are either registered trademarks or trademarks of Intel Corporation.

SDXC Logo is a trademark of SD-3C, LLC.



Adobe, the Adobe logo and Adobe Reader are either registered trademarks or trademarks of Adobe Systems Incorporated in the United States and/or other countries.

Bluetooth® is a registered trademark owned by Bluetooth SIG, Inc., U.S.A. and licensed to Panasonic Corporation.

HDMI, the HDMI Logo and High-Definition Multimedia Interface are trademarks or registered trademarks of HDMI Licensing LLC in the United States and other countries.

Roxio Creator is a trademark or registered trademark of Corel Corporation in the United States and/or other countries.

Names of products, brands, etc., appearing in this manual are trademarks or registered trademarks of their respective own companies.

# Description of Parts

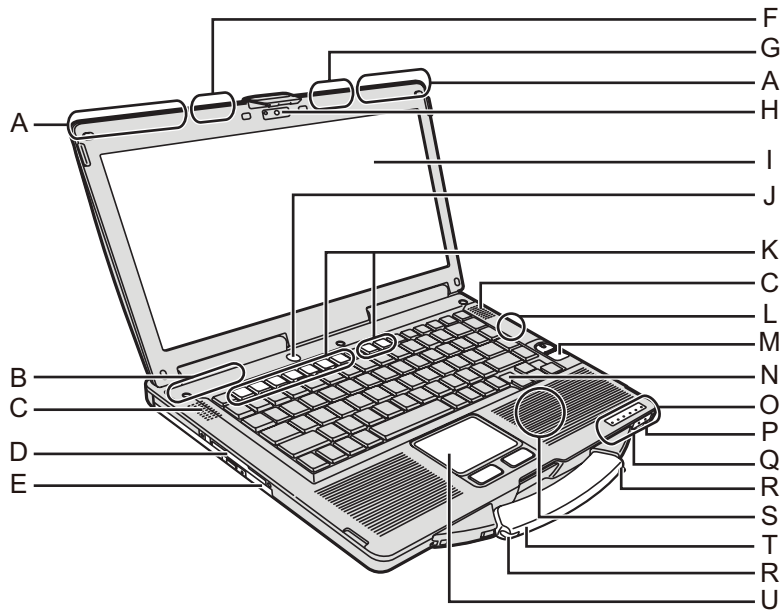

## A: Wireless WAN antenna

<Only for model with wireless WAN>  
 → *Reference Manual* "Wireless LAN"

## B: Wireless LAN antenna/Bluetooth antenna

<Only for model with Bluetooth>  
 → *Reference Manual* "Bluetooth"

## C: Speaker

→ *Reference Manual* "Key Combinations"

## D: Smart Card slot

<Only for model with Smart Card slot>  
 → *Reference Manual* "Smart Card"

## E: CD/DVD Drive

→ *Reference Manual* "CD/DVD Drive"

## F: Wireless LAN antenna/Bluetooth antenna

<Only for model with wireless LAN>  
 → *Reference Manual* "Wireless LAN"

## G: Wireless LAN antenna/Bluetooth antenna

<Only for model with wireless LAN and without GPS>  
 → *Reference Manual* "Wireless LAN"

## GPS antenna

<Only for model with GPS>

## H: Camera

<Only for model with Camera>  
 → *Reference Manual* "Camera"

## I: LCD

<Only for model with touchscreen>  
 → *Reference Manual* "Screen Input Operation"

## J: Power switch

## K: Function key

→ *Reference Manual* "Key Combinations"

## L: Wireless LAN antenna/Bluetooth antenna

<Only for model with wireless LAN and GPS>  
 → *Reference Manual* "Wireless LAN"

## M: Fingerprint Reader

<Only for model with Fingerprint Reader>  
 → *Reference Manual* "Fingerprint Reader"

## N: Keyboard

## O: LED indicator

: Caps lock

: Numeric key (NumLk)

: Scroll lock (ScrLk)

: Drive status

: SD Memory Card status

(Blinking: During access or a password is requested)

→ *Reference Manual* "SD Memory Card"

: Wireless ready

This indicator lights when Wireless LAN, Bluetooth, and/or Wireless WAN are connected and ready. It does not necessarily indicate the On/Off condition of the wireless connection.

→ *Reference Manual* "Disabling/Enabling Wireless Communication" "Wireless LAN" "Bluetooth" "Wireless WAN"

: Battery status

→ *Reference Manual* "Battery Power"

: Power status

(Off: Power off/Hibernation, Green: Power on, Blinking green: Sleep, Blinking green rapidly: Cannot power on or resume due to low temperature.)

## P: Microphone jack

A condenser microphone can be used. If other types of microphones are used, audio input may not be possible, or malfunctions may occur as a result.

## Q: Headphone jack

You can connect headphones or amplified speakers. When they are connected, audio from the internal speakers is not heard.

## R: Stylus Holder

<Only for model with touchscreen>

## S: RFID Reader

<Only for model with RFID Reader>

→ *Reference Manual* "RFID Reader"

## T: Carrying handle

## U: Touch pad

## Right side

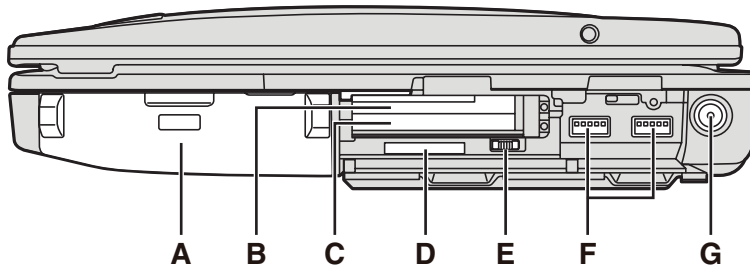

## Rear side

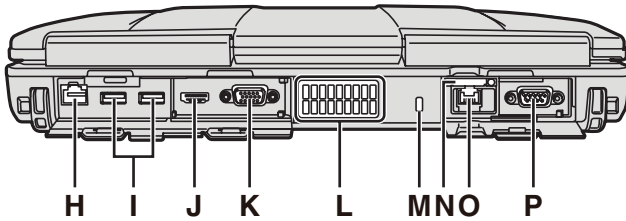

## Bottom

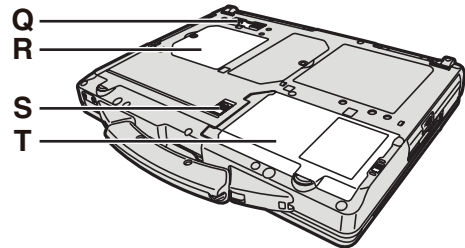

### A: Battery pack

Specified Battery pack: CF-VZSU71U/CF-VZSU72U

### B: ExpressCard slot<sup>1</sup> / PC Card slot<sup>2</sup>

→ Reference Manual "PC Card / ExpressCard"

<sup>1</sup> Only for model with ExpressCard slot

<sup>2</sup> Only for model without ExpressCard slot

### C: PC Card slot

→ Reference Manual "PC Card / ExpressCard"

### D: SD Memory Card slot

Keep SD Memory Cards Away from Infants and Small Children.

→ Reference Manual "SD Memory Card"

### E: Wireless switch

→ Reference Manual "Disabling/Enabling Wireless Communication" "Wireless LAN" "Bluetooth" "Wireless WAN"

### F: USB 3.0 port

→ Reference Manual "USB Devices"

### G: DC-IN jack

### H: LAN port

→ Reference Manual "LAN"

### I: USB 2.0 port

→ Reference Manual "USB Devices"

### J: HDMI Port

→ Reference Manual "External Display"

### K: VGA port

→ Reference Manual "External Display"

### L: Ventilation hole (Exhaust)

### M: Security lock

A Kensington cable can be connected.

For further information, read the manual that comes with the cable.

### N: SIM Card slot

<Only for model with Wireless WAN>

→ Reference Manual "Wireless WAN"

### O: 2nd LAN Port<sup>3</sup> / Modem Port<sup>4</sup> / IEEE 1394 Interface Connector<sup>5</sup> / Rugged USB 2.0 Port<sup>6</sup>

<sup>3</sup> Only for model with 2nd LAN

→ Reference Manual "LAN"

<sup>4</sup> Only for model with Modem

→ Reference Manual "Modem"

<sup>5</sup> Only for model with IEEE 1394

→ Reference Manual "IEEE 1394 Devices"

<sup>6</sup> Only for model with Rugged USB 2.0 Port

### P: Serial port

### Q: Expansion bus connector

→ Reference Manual "Port Replicator"

### R: RAM module slot

→ Reference Manual "RAM Module"

### S: Battery latch

### T: Hard disk drive

→ Reference Manual "Hard Disk Drive"

## NOTE

- When you open the covers on the right side or the rear side, push down and pull the covers.

(Example: rear side)

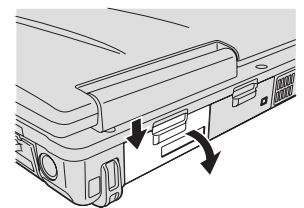

- This computer contains a magnet and magnetic products at the locations circled in the illustration at right. Avoid leaving metallic object or magnetic media in contact with these areas.





# First-time Operation

## ■ Preparation

① Check and identify the supplied accessories.

If you do not find the described accessories, contact Panasonic Technical Support.

- AC Adaptor..... 1
- AC Cord ..... 1
- Battery Pack ..... 1

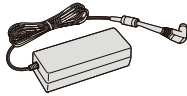

Model No: CF-AA5713A

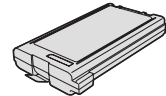
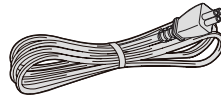

Model No: CF-VZSU71U or  
CF-VZSU72U

- OPERATING INSTRUCTIONS (This book)..... 1

<Only for model with touchscreen>

- Soft Cloth..... 1
- Stylus ..... 1
- Tether ..... 1

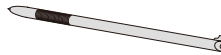
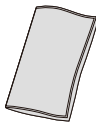

(→ Reference Manual “Screen Input Operation”)

② Read the LIMITED USE LICENSE AGREEMENT before breaking the seal on the computer’s packaging (→ page 32).

## ■ Inserting the Battery Pack

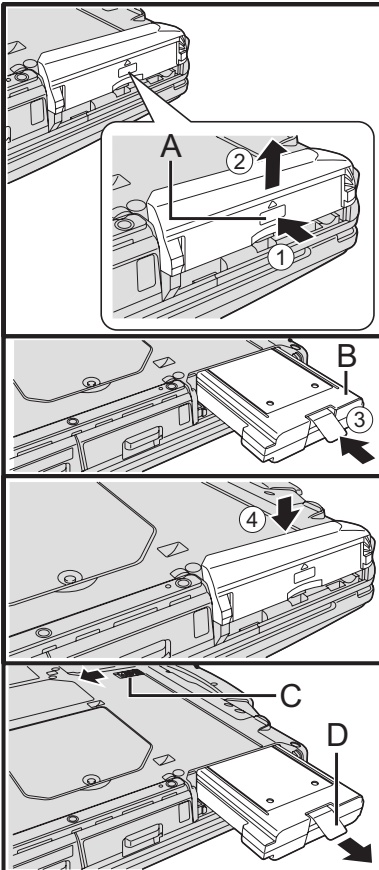

- ① Reverse the computer, then press and hold the **PUSH** mark part (A).
- ② Slide and remove the cover.
- ③ Insert the battery pack (B) until it securely fits the connector.
- ④ Slide the cover back.

### ■ To remove the battery pack

In step ③ above, slide and hold the latch (C), and pull the tab (D) of the battery pack.

#### CAUTION

- Make sure the cover is securely attached. Otherwise the battery pack may fall when you carry the computer.

#### NOTE

- Note that the computer consumes electricity even when the computer power is off. If the battery pack is fully charged, the battery will fully discharge in the following period of time:
  - When power is off: Approx. 9 weeks (with CF-VZSU71U) /  
Approx. 6 weeks (with CF-VZSU72U)
  - In sleep: Approx. 3.5 days (with CF-VZSU71U) /  
Approx. 2 days (with CF-VZSU72U)
  - In hibernation: Approx. 9 days (with CF-VZSU71U) /  
Approx. 6 days (with CF-VZSU72U)
- When the DC plug is not connected to the computer, disconnect the AC cord from your AC outlet. Power is consumed simply by having the AC adaptor plugged into an electrical outlet.

## ■ Attaching the stylus to the computer

<Only for model with touchscreen>

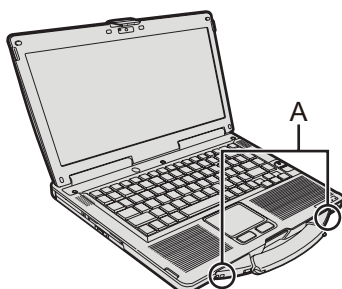

Use the tether to attach the stylus to the computer so you will not lose it. There are holes (A) to attach it.

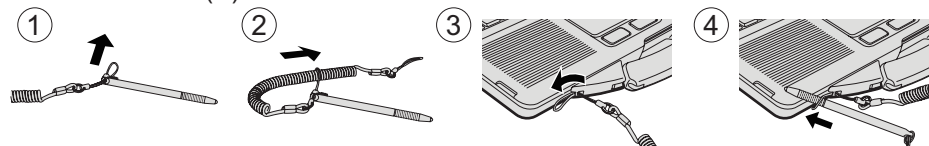

#### CAUTION

- Do not pull the tether with excessive force. The digitizer pen may hit the computer, person’s body or other objects when released.



## ■ Opening the Display

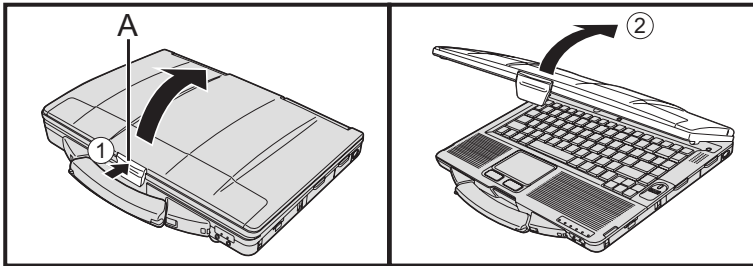

- ① Push the top of the latch (A) to release it.
- ② Lift up the display to open.

## ■ Setting up the computer

### 1 Insert the battery pack. (→ page 14)

- Do not touch the terminals of the battery pack and the computer. Doing so can make the terminals dirty or damaged, and may cause malfunction of the battery pack and the computer.
- Be sure to attach the cover for use.

### 2 Connect your computer to a power outlet.

The battery charging starts automatically.

#### CAUTION

- Do not disconnect the AC adaptor and do not switch the wireless switch to on until the first-time operation procedure is completed.
- When using the computer for the first time, do not connect any peripheral device except the battery pack and AC adaptor.
- **Handling the AC adaptor**  
Problems such as sudden voltage drops may arise during periods of thunder and lightning. Since this could adversely affect your computer, an uninterruptible power source (UPS) is highly recommended unless running from the battery pack alone.

### 3 Turn on the computer.

- ① Confirm the wireless switch (→ page 13) is OFF.
- ② Press and hold the power switch (→ page 12) until the power indicator (→ page 12) lights.

#### CAUTION

- Do not press the power switch repeatedly.
- The computer will be forcibly turned off if you press and hold the power switch for four seconds or longer.
- Once you turn off the computer, wait for ten seconds or more before you turn on the computer again.
- Do not perform the following operation until the drive indicator (→ page 12) turns off.
  - Connecting or disconnecting the AC adaptor
  - Pressing the power switch
  - Touching the keyboard, touch pad, touchscreen <only for model with touchscreen> or external mouse
  - Closing the display
  - Turn on/off the wireless switch
- When the CPU temperature is high, the computer may not start up to prevent overheating of the CPU. Wait until the computer cools down, and then turn the power on again. If the computer does not power on even after cooling down, contact Panasonic Technical Support.
- Any changes from the default setting of the Setup Utility must not be made until the First-time Operation is completed.

## 4 <For MUI OS model>

**Windows 8** Select language.

**Windows 7** Select language and OS (32-bit or 64-bit).

### CAUTION

**Windows 7**

- Carefully choose your language because you cannot change it later. If you set a wrong language, you need to reinstall Windows.

**Windows 8**

- ① Select language on “Your display language” and click [Next].  
Follow the on-screen instructions.

**Windows 7**

- ① Select language and OS (32bit or 64bit) on “Select OS” screen and click [OK].  
The language setting will start by clicking [OK] on the confirmation screen.  
You can return to the “Select OS” screen by clicking [Cancel].  
The language and OS setting will be completed in about 15 minutes.
- ② When termination screen is displayed, click [OK] to turn off the computer.
- ③ Turn on the computer.

## 5 Setup Windows.

Follow the on-screen instructions.

- The computer restarts several times. Do not touch the keyboard or touch pad, and wait until the drive indicator  has turned off.
- After the computer is turned on, the screen remains black or unchanged for a while, but this is not a malfunction. Wait for a moment until the Windows setup screen appears.
- During setup of Windows, use the touch pad and clicking to move the cursor and to click an item.
- Setup of Windows will take approximately **Windows 8** 5 minutes / **Windows 7** 20 minutes. Go to the next step, confirming each message on the display.
- You can set the Wireless Network after the setup of Windows is complete.  
**Windows 8** If “Choose a network” is displayed, you can select “Connect to a wireless network later”.  
**Windows 7** “Join a wireless network” screen may not appear.

### CAUTION

- You can change the user name, password, image and Wireless Networks after setup of Windows.
- Do not use the following words and characters for user name: CON, PRN, AUX, CLOCK\$, NUL, COM1 to COM9, LPT1 to LPT9, @, &, space. In particular, if you create a user name (account name) that includes the “@” mark, a password will be requested at the log-on screen, even if no password has been set. If you try to log on without entering a password, “The user name or password is incorrect.” may be displayed and you will not be able to **Windows 8** sign in / **Windows 7** log on to Windows (→ page 29).
- Use standard characters as a computer name: numbers 0 through 9, uppercase and lowercase letters from A to Z, and the hyphen (-) character.  
If the error message “The computer name is not valid” appears, check if characters other than the above are not entered. If the error message still remains on the display, set the key entry mode to English (“EN”) and enter characters.

<For MUI OS model>



- When setting up the keyboard, choose the appropriate one to your computer. Otherwise, input by the keyboard may become unavailable.

## 6 **Windows 8** Set the time zone, and then set the date and time.

- ① Open the Control Panel.
  1. Long touch any empty location on the Start screen.
  2. Click [All apps] on the app bar.
  3. Click [Control Panel] under “Windows System”.
- ② Click [Clock, Language, and Region] - [Date and Time].
- ③ Click [Change time zone...].
- ④ Select the time zone, then click [OK].
- ⑤ Click [Change date and time...], then set the date and time.

## 7 Restart the computer.

- Windows 8**
- ① Display “Charm” and click .
  - ② Click [Power] - [Restart].

- Windows 7**
- ① Click  (Start) -  - [Restart].

## 8 Create the recovery disc.

If the recovery partition of the hard disk is damaged or have some problems, you can use a recovery disc to install the OS and restore its factory default condition. We recommend creating a recovery disc before you begin using the computer. Refer to  *Reference Manual* “Recovery Disc Creation Utility” about creating the disc.

### NOTE

#### ● PC Information Viewer

This computer periodically records the management information of the hard disk, etc. The maximum data volume for each record is 1024 bytes. This information is only used for estimating the cause in the case when the hard disk goes down by any possibility. They are never sent to outside via network nor used for any other purpose except for the purpose described the above.

To disable the function, add the check mark for [Disable the automatic save function for management information history] in [Hard Disk Status] of PC Information Viewer, and click [OK].

(→  *Reference Manual* “Checking the Computer’s Usage Status”)

#### ● **Windows 8** <For MUI OS model>

In the default settings, a shortcut icon for Korean language is on the Desktop screen. You may delete the icon if not necessary.

#### ■ Before using wireless function

- ① Slide the wireless switch to ON.

##### **Windows 8**

- ② Display “Charm” -  - [Change PC Settings] - [Wireless].
  - Set [Airplane mode] to [Off], and then;
  - set [Wi-Fi] to [On] (for wireless LAN).
  - set [Mobile broadband] to [On] (for wireless WAN).
  - set [GPS] to [On] (for wireless WAN).
  - set [Bluetooth] to [On] (for Bluetooth).

# First-time Operation

## ■ To change the partition structure

You can shrink a part of an existing partition to create unallocated disk space, from which you can create a new partition.

### ① **Windows 8**

Open "Computer". Right-click [Computer], then click [Manage].

To open "Computer", proceed as follows on the Start screen.

1. Right-click any empty location on the Start screen.
2. Click [All apps] on the app bar.
3. Click [Computer] under "Windows System".

### **Windows 7**

Click  (Start) and right-click [Computer], then click [Manage].

- A standard user needs to enter an administrator password.

### ② Click [Disk Management].

### ③ Right-click the partition for Windows ("c" drive in the default setting), and click [Shrink Volume].

- The partition size depends on the computer specifications.

### ④ Input the size in [Enter the amount of space to shrink in MB] and click [Shrink].

- You cannot input a larger number than the displayed size.
- To select [Reinstall to the System and OS partitions.] in reinstalling the software (→page 24), the following size is necessary for [Total size after shrink in MB].

**Windows 8** 70000 MB<sup>\*1</sup> or more

**Windows 7** 60000 MB or more

### ⑤ Right-click [Unallocated] (the shrunk space in the step ④) and click [New Simple Volume].

### ⑥ Follow the on-screen instructions to make the settings, and click [Finish].

Wait until formatting is completed.

<sup>\*1</sup> For MUI OS model, 80 GB or more is necessary.

## NOTE

- You can create an additional partition using remaining unallocated space or newly creating unallocated space.
- To delete a partition, right-click the partition and click [Delete Volume] in the step ③.

## ■ **Windows 8** <For MUI OS model> To select language

To select a language other than the one you have selected during the first-time operation, follow the steps below.

### ① Open the Control Panel.

1. Right-click any empty location on the Start screen.
2. Click [All apps] on the app bar.
3. Click [Control Panel] under "Windows System".

### ② Click [Clock, Language, and Region] - [Language] - [Add a language].

### ③ Select a language, and then click [Add].

Depending on the region, two or more languages are selectable. Click [Open] and select the desired language, and then click [Add].

### ④ Click [Option] for the language you want to use.

### ⑤ Click [Make this the primary language].

## NOTE



- If [Make this the primary language] is not displayed, you cannot change to this language. Follow the on-screen instructions.

### ⑥ Click [Log off now].

### ⑦ Sign in to the Windows.

# Turning On / Turning Off

## Turning On

Press and hold the power switch  (→ page 12) until the power indicator  (→ page 12) lights.

### NOTE

- Do not press the power switch repeatedly.
- The computer will forcibly be turned off if you press and hold the power switch for four seconds or longer.
- Once you turn off the computer, wait for ten seconds or more before you turn on the computer again.
- Do not perform the following operation until the drive indicator  turns off.
  - Connecting or disconnecting the AC adaptor
  - Pressing the power switch
  - Touching the keyboard, touch pad, screen or external mouse
  - Closing the display
  - Turn on/off the wireless switch

## Turning Off

- ① Shut down the computer.

### Windows 8

1. Display “Charm” and click .
2. Click [Power] - [Shut down].

### Windows 7

- Click  (Start) - [Shutdown].

### NOTE

- **Windows 8**  
To turn off the computer, proceed as follows.
  - ① Display “Charm” and click  - [Change PC settings] - [General].
  - ② Click [Restart now] under “Advanced startup”.
  - ③ Click [Turn off your PC].

## Precautions against Starting Up/Shutting Down

- Do not do the following
  - Connecting or disconnecting the AC adaptor
  - Pressing the power switch
  - Touching the keyboard, touch pad, screen or external mouse
  - Closing the display
  - Turn on/off the wireless switch

### NOTE

- To conserve power, the following power saving methods are set at the time of purchase.
  - The screen automatically turns off after :
    - 10 minutes (when AC adaptor is connected) of inactivity
    - 5 minutes (when operating on battery power) of inactivity
  - The computer automatically enters sleep<sup>\*1</sup> after :
    - Windows 8** 30 minutes / **Windows 7** 20 minutes (when AC adaptor is connected) of inactivity
    - 15 minutes (when operating on battery power) of inactivity

<sup>\*1</sup> Refer to  *Reference Manual* “Sleep or Hibernation Functions” about resuming from sleep.

# On-screen Manual

You can access the following manuals on the computer screen.

## ■ Reference Manual

The Reference Manual contains the practical information to help you fully enjoy the computer's performance.

## ■ Important Tips

The Important Tips will provide you with the battery information so that you can use the battery pack in the optimum condition to obtain longer operation time.

## ■ To access the on-screen manuals

Follow the steps below.

**Windows 8** On the Start screen, touch the [Manual Selector] tile, and select the on-screen manual.

Double-click [Manual Selector] on the desktop screen, and select the on-screen manual.

**Windows 7**

### To access the Reference Manual:

Double-click  on the desktop.

- Alternatively click  (Start) - [All Programs] - [Panasonic] - [On-Line Manuals] - [Reference Manual].

### To access the Important Tips:

Double-click  on the desktop.

- Alternatively click  (Start) - [All Programs] - [Panasonic] - [On-Line Manuals] - [Important Tips].



# Handling and Maintenance

## Operation environment

- Place the computer on a flat stable surface not subject to shock, vibration, and danger of dropping. Do not place the computer upright or turn it over. If the computer is exposed to an extremely strong impact, it may become damaged.
- Operating environment
  - Temperature: Operation : <Model without HDD heater> 0 °C to 50 °C (IEC60068-2-1, 2)<sup>\*1</sup>  
<Model with HDD heater> -10 °C to 50 °C (IEC60068-2-1, 2)<sup>\*1</sup>
  - Storage : -20 °C to 60 °C
  - Humidity: Operation : 30% to 80% RH (No condensation)
  - Storage : 30% to 90% RH (No condensation)

Even within the above temperature/humidity ranges, operation for a long time in extreme environments, smoking nearby, or operation in places where oil is used or where there is a lot of dust will result in the product deterioration and will shorten the product life.

<sup>\*1</sup> Do not expose the skin to this product when using the product in a hot or cold environment. (→ page 4)

If the computer is wet in temperatures of 0 °C or below, freeze damage may occur. Make sure to dry off the computer in such temperatures.

- Do not place the computer in the following areas, otherwise the computer may be damaged.
  - Near electronic equipment. Image distortion or noise may occur.
  - In extremely high or low temperature.
- As the computer can become hot during operation, keep it away from items that are sensitive to heat.

## Handling cautions

This computer is designed to minimize shock to parts such as the LCD and the hard disk drive and equipped with a drip-proof keyboard, but no warranty is provided against any trouble caused by shock. Be extremely careful when handling the computer.

- When carrying the computer:
  - Turn off the computer.
  - Remove all external devices, cables, PC Cards and other protruding objects.
  - Remove a disc in the CD/DVD drive.
  - Do not drop or hit the computer against solid objects.
  - Do not leave the display open.
  - Do not grip the display part.
- Do not put anything (e.g., a piece of paper) between the display and keyboard.
- When you board an airplane, take the computer with you and never put it in your checked luggage. When using the computer on airplane, follow the airline's instructions.
- When carrying a spare battery, put it in a plastic bag to protect its terminals.
- The touch pad is designed to be used by finger tip. Do not place any object on its surface and do not press down strongly with sharp-pointed or hard objects that may leave marks (e.g., nails, pencils and ball point pens).
- Avoid any harmful substances such as oil from getting into the touch pad. The cursor may not work correctly.
- Be careful not to get injured by dropping or getting hit when carrying the computer.

<Only for model with touchscreen>

- Use only the included stylus to touch the touchscreen. Do not place any object on its surface and do not press down strongly with sharp-pointed or hard objects that may leave marks (e.g., nails, pencils and ball point pens).
- Do not use the touchscreen when dust or dirt (e.g., oil) is on the screen. Otherwise foreign particles on the screen/stylus can scratch the screen surface or obstruct the stylus operation.
- Use the stylus only for touching the screen. Using it for any other purpose may damage the stylus and result in scratches on the screen.

### ■ When using peripheral devices

Follow these instructions and the Reference Manual to avoid any damage to the devices. Carefully read the instruction manuals of the peripheral devices.

- Use the peripheral devices conforming to the computer's specifications.
- Connect to the connectors in the correct direction.
- If it is hard to insert, do not try forcibly but check the connector's shape, direction, alignment of pins, etc.
- If screws are included, fasten them securely.
- Remove the cables when you carry the computer. Do not pull the cables forcibly.

# Handling and Maintenance

## ■ Preventing your computer from unauthorized use via wireless LAN/Bluetooth/wireless WAN

<Only for model with wireless LAN/Bluetooth/wireless WAN>

- Before using wireless LAN/Bluetooth/wireless WAN, make the appropriate security settings such as data encryption.

## ■ Battery Recalibration

- The battery recalibration may take a long time due to the large battery capacity. This is not a malfunction.

<When performing "Battery Recalibration" after shutting down Windows>

- Full charge: Approximately 2 hours
- Complete discharge: Approximately 3 hours (with CF-VZSU71U) / Approx. 2 hours (with CF-VZSU72U)

When performing "Battery Recalibration" without shutting down Windows, it may take more time to charge / discharge.

## Maintenance

If drops of water or other stains get on the surface of the LCD panel, wipe them off immediately. Failure to do so may result in staining.

### To clean the LCD panel

<Only for model with touchscreen>

Use the soft cloth included with the computer. (For further information, refer to "Suggestions About Cleaning the LCD Surface". →  *Reference Manual* "Screen Input Operation")

<Only for model without touchscreen>

Wipe with a soft dry cloth such as gauze.

### To clean areas other than the LCD panel

Wipe with a soft dry cloth such as gauze. When using detergent, dip a soft cloth in water-diluted detergent and wring it thoroughly.

### CAUTION

- Do not use benzene, thinner, or rubbing alcohol since it may adversely affect the surface causing discoloration, etc. Do not use commercially-available household cleaners and cosmetics, as they may contain components harmful to the surface.
- Do not apply water or detergent directly to the computer, since liquid may enter inside of the computer and cause malfunction or damage.

# Installing Software

Installing software will return the computer to the default condition. When you install the software, the hard disk data will be erased.

Back up important data to other media or an external hard disk before installation.

## CAUTION

- Do not delete the Recovery Partition on the hard disk. The disk space in the partition is not available to store data. To check the Recovery Partition, perform the following methods.

### ① Windows 8

Open “Computer”. Right-click [Computer], then click [Manage].

To open “Computer”, proceed as follows on the Start screen.

1. Right-click any empty location on the Start screen.
2. Click [All apps] on the app bar.
3. Click [Computer] under “Windows System”.

### Windows 7

Click  (Start) and right-click [Computer], then click [Manage].

- A standard user needs to enter an administrator password.

### ② Click [Disk Management].

## ■ Hard Disk Recovery

You can reinstall the OS that was pre-installed at the time of purchase (Windows 8 or Windows 7).

### Preparation

- Remove all peripherals.
- Connect the AC adaptor and do not remove it until installation is complete.

### Windows 8

## 1 Perform “Remove everything and reinstall Windows”.

① Display “Charm” and click  - [Change PC settings] - [General].

② Click [Get Started] under “Remove everything and reinstall Windows”.

③ Select the option.

- Just remove my files

Perform the reinstallation of the Windows in a few moments (Approximately 20 minutes).

- Fully clean the drive

By fully cleaning, the deleted files can not be recovered easily and the security level will be increased.

The processing time will be longer (Approximately 140 minutes).

Follow the on-screen instructions.

After the reinstallation, the computer will restart.

- Do not interrupt installation, for example by turning off the computer or pressing **Ctrl + Alt + Del**.

Otherwise installation may become unavailable as Windows may not start up or the data may be corrupted.

## 2 Perform the “First-time Operation” (→ page 16).

### NOTE

- The date and time, and the time zone may not be correct. Be sure to set them correctly.

## 3 Perform Windows Update.

## 4 <Only for model with TPM> Clear TPM.

① Right-click any empty location on the Start screen, and click [All apps] on the app bar.

② Click [Run] under “Windows System” input [tpm.msc] and click [OK].

③ Click [Clear TPM...] under “Actions” on the right of the “TPM Manager on Local Computer” screen.

④ Click [Restart] of the “Manage the TPM security hardware” screen.

The computer will restart.

⑤ When “TPM configuration change was requested to ...” is displayed, press **F12**.

The desktop screen appears.

⑥ Click the Desktop tile, and when “TPM is ready” appears, click [Close].

### Windows 7

## 1 Turn on the computer, and press **F2** or **Del** while [Panasonic] boot screen is displayed.

The Setup Utility starts up.

- If the [Panasonic] boot screen is not displayed, turn on the computer while holding down **F2** or **Del**.
- If the password is requested, enter the Supervisor Password.

## 2 Write down all of the contents of the Setup Utility and press **F9**.

At the confirmation message, select [Yes] and press **Enter**.

# Installing Software

- 3 Press F10.**  
At the confirmation message, select [Yes] and press Enter.  
Computer will restart.
- 4 Press F2 or Del while [Panasonic] boot screen is displayed.**  
The Setup Utility starts up.
  - If the password is requested, enter the Supervisor Password.
- 5 Select the [Exit] menu, then select [Recovery Partition] and press Enter.**
- 6 Click [Reinstall Windows] and click [Next].**  
The License Agreement screen appears.
- 7 Click [Yes, I agree to the provisions above and wish to continue!] and click [Next].**
- 8 Select the settings and click [Next].**
  - [Reinstall Windows to the whole Hard Disk to factory default.]  
Select this option when you want to reinstall Windows to the factory default. After reinstallation, you can create a new partition. For how to create a new partition, refer to “To change the partition structure” (→ page 18).
  - [Reinstall to the System and OS partitions.]<sup>\*1</sup>  
Select this option when the hard disk has already been divided into several partitions. For how to create a new partition, refer to “To change the partition structure” (→ page 18).  
You can keep the partition structure.  
\*1 This does not appear if Windows cannot be reinstalled to the partition containing boot files and the area usable by Windows.
- 9 At the confirmation message, click [OK].**
- 10 <For localized OS model>**  
**Select OS (32bit or 64bit) and click [OK].**  
**<For MUI OS model>**  
**Select language and OS (32bit or 64bit), then click [OK].**
- 11 At the confirmation message, click [OK].**  
Reinstallation starts according to the instructions on the screen.
  - Do not interrupt installation, for example by turning off the computer or pressing Ctrl + Alt + Del.  
Otherwise installation may become unavailable as Windows may not start up or the data may be corrupted.
- 12 When ending screen is displayed, click [OK] to turn off the computer.**
- 13 Turn on the computer.**
  - If the password is requested, enter the Supervisor Password.
- 14 Perform the “First-time Operation” (→ page 16).**
- 15 Start the Setup Utility and change the settings as necessary.**
- 16 Perform Windows Update.**

## ■ Using Recovery Disc

Use the Recovery Disc in the following conditions.

- You have forgotten the administrator password.
- Installation is not complete. The recovery partition in the hard disk may be broken.
- **Windows 7** <Only for Windows 7 downgrade model> To change OS from Windows 7 to Windows 8, or vice versa.

### NOTE

- **Windows 7** To change OS from 32 bit to 64 bit, or vice versa, install OS using the recovery partition in the hard disk.

### Preparation

- Prepare the following items:
  - Recovery Disc(s) (→  *Reference Manual* “Recovery Disc Creation Utility”)
    - **Windows 8** Operation using DVD is explained below.
- Remove all peripherals.
- Connect the AC adaptor and do not remove it until installation is complete.

### 1 Start the Setup Utility.

#### **Windows 8**

- ① Display “Charm” and click  - [Change PC settings] - [General].
- ② Click [Restart now] under “Advanced startup”.
- ③ Click [Troubleshoot] - [Advanced options] - [UEFI Firmware Settings] - [Restart].

#### **Windows 7**

Turn on the computer, and press **F2** or **Del** while [Panasonic] boot screen is displayed.

- If the [Panasonic] boot screen is not displayed, turn on the computer while holding down **F2** or **Del**.
- If the password is requested, enter the Supervisor Password.

### 2 Write down all of the contents of the Setup Utility and press **F9**.

At the confirmation message, select [Yes] and press **Enter**.

### 3 Check the [UEFI Boot] setting of the Setup Utility.

[UEFI Boot] should be set to as follows.

When the recovery disc for Windows 8 is used: [Enabled]

When the recovery disc for Windows 7 is used: [Disabled]

### 4 Set the Recovery Disc into the DVD drive.

### 5 Press **F10**.

At the confirmation message, select [Yes] and press **Enter**.

Computer will restart.

### 6 Press **F2** or **Del** while [Panasonic] boot screen is displayed.

The Setup Utility starts up.

- If the password is requested, enter the Supervisor Password.

### 7 Select the [Exit] menu, then select your DVD drive in [Boot Override].

### 8 Press **Enter**.

The computer will restart.

### 9 Click [Reinstall Windows] and click [Next].

### 10 **Windows 8** At the confirmation message, click [YES].

### 11 At the License Agreement screen, click [Yes, I agree to the provisions above and wish to continue!] and click [Next].

### 12 When the recovery disc for Windows 8 is used, click [Next].

**When the recovery disc for Windows 7 is used, select the setting and click [Next].**

- [Reinstall Windows to the whole Hard Disk to factory default.]  
Select this option when you want to install Windows to the factory default. After installation, you can create a new partition. For how to create a new partition, refer to “To change the partition structure” (→ page 18)
- [Reinstall to the System and OS partitions.]<sup>2</sup>  
Select this option when the hard disk has already been divided into several partitions. For how to create a new partition, refer to “To change the partition structure” (→ page 18).  
You can keep the partition structure.

<sup>2</sup> This does not appear if Windows cannot be installed to the recovery partition and the area usable by Windows.

# Installing Software

## 13 At the confirmation message, click [YES].

Installation starts according to the instructions on the screen. (It will take approximately 30 - 45 minutes.)

- Do not interrupt installation, for example by turning off the computer or pressing **Ctrl + Alt + Del**.  
Otherwise installation may become unavailable as Windows may not start up or the data may be corrupted.

## 14 When ending screen is displayed, remove the Recovery Disc.

Follow the on-screen instructions.

Some models may take approximately 40 minutes.

## 15 Perform the “First-time Operation” (→ page 16).

---

### NOTE

- The date and time, and the time zone may not be correct. Be sure to set them correctly.
- 

## 16 Start the Setup Utility and change the settings as necessary.

## 17 Perform Windows Update.

## 18 **Windows 8** <Only for model with TPM> Clear TPM (→ page 23).



# Troubleshooting (Basic)





Follow the instructions below when a problem has occurred. There is also an advanced troubleshooting guide in the "Reference Manual". For a software problem, refer to the software's instruction manual. If the problem persists, contact Panasonic Technical Support. You can also check the computer's status in the PC Information Viewer (→  *Reference Manual* "Checking the Computer's Usage Status").

## ■ Starting Up



<p>Cannot start up. The power indicator or battery indicator is not lit.</p>	<ul style="list-style-type: none"> <li>● Connect the AC adaptor.</li> <li>● Insert a fully charged battery.</li> <li>● Remove the battery pack and the AC adaptor, then connect them again.</li> <li>● Even if the AC adaptor and battery pack are correctly connected, if the battery indicator is not lit, the AC adaptor protection function may be operating. Disconnect the AC cord, wait three minutes or more, and reconnect the AC cord.</li> <li>● If a device is connected to the USB port, disconnect the device, or set [USB Port] or [Legacy USB Support] to [Disabled] in the [Advanced] menu of the Setup Utility.</li> <li>● If a device is connected to the ExpressCard slot, disconnect the device, or set [ExpressCard Slot] to [Disabled] in the [Advanced] menu of the Setup Utility.</li> <li>● Press <b>Fn</b> + <b>F8</b> to turn off the concealed mode.</li> <li>● Check the [UEFI Boot] setting of the Setup Utility. [UEFI Boot] should be set to <b>Windows 8</b> [Enabled] / <b>Windows 7</b> [Disabled].</li> </ul>
<p>The power is turned on but "Warming up the system (up to 30 minutes)" appears.</p>	<ul style="list-style-type: none"> <li>● The computer is warming up before start up. Wait for the computer to start up (takes up to 30 minutes). If, "Cannot warm up the system" is displayed, the computer failed to warm up and does not start. In this case, turn off the computer, leave it in an environment of 5 °C or higher temperature for about an hour, and then turn on the power once more.</li> </ul>
<p>After adding or changing the RAM module, the power is turned on but nothing is displayed on the screen.</p>	<ul style="list-style-type: none"> <li>● Turn off the computer and remove the RAM module, then confirm whether the RAM module has conformed to specification. When the RAM module has conformed to specification, install it again.</li> </ul>
<p>The computer does not enter sleep mode while the screen saver is running. (The screen stays black.)</p>	<ul style="list-style-type: none"> <li>● Press and hold the power switch for 4 seconds or longer to shut down the computer forcibly. (Data not saved will be lost.) Then disable the screen saver.</li> </ul>
<p>It takes time for the power indicator to light up.</p>	<ul style="list-style-type: none"> <li>● If the power switch is pressed immediately after the battery pack has been mounted on the computer, and while the AC adaptor is not connected, it may take about five seconds before the power indicator lights up and the computer turns on. This is because the computer is checking the remaining battery charge; it is not a malfunction.</li> </ul>
<p>You have forgotten the password.</p>	<ul style="list-style-type: none"> <li>● Supervisor Password or User Password: Contact Panasonic Technical Support.</li> <li>● Administrator password: <ul style="list-style-type: none"> <li>• If you have another account with Administrator authority, log-on with it, then delete the password for the problem account.</li> <li>• If you have a password reset disk, click [Reset password] displayed after the password input error, then follow the on-screen instructions and set a new password. If you cannot do either of the above, you will need to reinstall (→ page 23) and setup Windows.</li> </ul> </li> </ul>
<p>"Remove disks or other media. Press any key to restart" or a similar message appears.</p>	<ul style="list-style-type: none"> <li>● A floppy disk is in the drive or USB memory is connected, and it does not contain system startup information. Remove the floppy disk and USB memory, then press any key.</li> <li>● If a device is connected to the USB port, disconnect the device, or set [USB Port] or [Legacy USB Support] to [Disabled] in the [Advanced] menu of the Setup Utility.</li> <li>● &lt;Only for model with ExpressCard slot&gt; If a device is connected to the ExpressCard slot, disconnect the device, or set [ExpressCard Slot] to [Disabled] in the [Advanced] menu of the Setup Utility.</li> <li>● If the problem persists after removing the disk, it may be a hard disk failure. Contact Panasonic Technical Support.</li> <li>● Set [UEFI Boot] to [Disabled] in the [Boot] menu of the Setup Utility.</li> </ul>
<p>Windows startup and operation is slow.</p>	<ul style="list-style-type: none"> <li>● Press <b>F9</b> in the Setup Utility (→  <i>Reference Manual</i> "Setup Utility") to return the Setup Utility settings (excluding the passwords) to the default values. Start the Setup Utility and make the settings again. (Note that the processing speed depends on the application software, so this procedure may not make Windows faster.)</li> <li>● If you installed a resident software after purchase, turn off the residence.</li> </ul>

# Troubleshooting (Basic)



## ■ Starting Up

<p>The date and time are incorrect.</p>	<ul style="list-style-type: none"> <li>● Make the correct settings.               <ol style="list-style-type: none"> <li>① Open the Control Panel.                   <ul style="list-style-type: none"> <li><b>Windows 8</b></li> <li>1. Right-click any empty location on the Start screen.</li> <li>2. Click [All apps] on the app bar.</li> <li>3. Click [Control Panel] under “Windows System”.</li> </ul> </li> <li><b>Windows 7</b></li> <li>Click  (Start) - [Control Panel].</li> <li>② Click [Clock, Language, and Region] - [Date and Time].</li> </ol> </li> <li>● If the problem persists, the internal clock battery may need to be replaced. Contact Panasonic Technical Support.</li> <li>● When the computer is connected to LAN, check the date and time of the server.</li> <li>● The 2100 A.D. or later year will not be correctly recognized on this computer.</li> </ul>
<p>[Executing Battery Recalibration] screen appears.</p>	<ul style="list-style-type: none"> <li>● The Battery Recalibration was canceled before Windows was shut down last time. To start up Windows, turn off the computer by the power switch, and then turn on.</li> </ul>
<p>[Enter Password] does not appear when resuming from sleep (<b>Windows 7</b>) / hibernation.</p>	<ul style="list-style-type: none"> <li>● Select [Enabled] in [Password On Resume] in the [Security] menu of the Setup Utility (→  <i>Reference Manual</i> “Setup Utility”).</li> <li>● The Windows password can be used instead of the password set in the Setup Utility.           <ul style="list-style-type: none"> <li>• To set a password               <ul style="list-style-type: none"> <li><b>Windows 8</b></li> <li>① Display “Charm” and click  - [Change PC settings] - [Users].</li> <li>② Click [Create a password] under “Sign-in options”.</li> </ul> </li> <li><b>Windows 7</b></li> <li>① Click  (Start) - [Control Panel] - [User Accounts and Family Safety] - [Add or remove user accounts].</li> </ul> </li> <li>Follow the on-screen instructions.</li> <li>● Perform the following steps, and the password will be requested when the computer resumes from sleep (<b>Windows 7</b>) / hibernation.           <ol style="list-style-type: none"> <li>① Open the Control Panel.               <ul style="list-style-type: none"> <li><b>Windows 8</b></li> <li>1. On the Start screen, flick from bottom side to inside of the screen.</li> <li>2. Click [All apps] on the app bar.</li> <li>3. Click [Control Panel] under “Windows System”.</li> </ul> </li> <li><b>Windows 7</b></li> <li>Click  (Start) - [Control Panel].</li> <li>② Click [System and Security] - [Require a password when the computer wakes] and add a check mark for [Require a password].</li> </ol> </li> </ul>
<p>Cannot resume.</p>	<ul style="list-style-type: none"> <li>● One of the following operations may have been carried out. Press the power switch turn on the computer. Data not saved will be lost.           <ul style="list-style-type: none"> <li>• In sleep mode, the AC adaptor or battery pack was disconnected, or a peripheral was connected or disconnected.</li> <li>• The power switch was pressed for four seconds or longer to forcibly turn off the computer.</li> </ul> </li> <li>● An error may occur when the computer automatically enters the sleep or hibernation mode while the screen saver is active. In this case, turn off the screen saver or change the pattern of the screen saver.</li> </ul>

## ■ Starting Up

<p>Other startup problems.</p>	<ul style="list-style-type: none"> <li>● Press <b>F9</b> in the Setup Utility (→  Reference Manual “Setup Utility”) to return the Setup Utility settings (excluding the passwords) to the default values. Start the Setup Utility and make the settings again.</li> <li>● Remove all peripheral devices.</li> <li>● Check to see if there was a disk error.             <ol style="list-style-type: none"> <li>① Remove all peripheral devices including an external display.</li> <li>② Open “Computer”.                 <ul style="list-style-type: none"> <li><b>Windows 8</b> <ol style="list-style-type: none"> <li>1. Right-click any empty location on the Start screen.</li> <li>2. Click [All apps] on the app bar.</li> <li>3. Click [Computer] under “Windows System”.</li> </ol> </li> <li><b>Windows 7</b> <ul style="list-style-type: none"> <li>Click  (Start) - [Computer].</li> </ul> </li> </ul> </li> <li>③ Right-click [Local Disk (C:)], and click [Properties].</li> <li>④ Click [Tools] - [Check Now...].                 <ul style="list-style-type: none"> <li>• A standard user needs to enter an administrator password.</li> </ul> </li> <li>⑤ Select the option in [Check disk options] and click [Start].</li> <li>⑥ Click [Schedule disk check] and restart the computer.</li> </ol> </li> <li>● <b>Windows 7</b> <p>Start the computer in Safe Mode and check the error details. When the [Panasonic] boot screen disappears<sup>*1</sup> at startup, press and hold <b>F8</b> until the Windows Advanced Options Menu is displayed. Select the Safe Mode and press <b>Enter</b>.</p> <p><sup>*1</sup> When [Password on boot] is set to [Enabled] in the [Security] menu of the Setup Utility, [Enter Password] appears after the [Panasonic] boot screen disappears. As soon as you enter the password and press <b>Enter</b>, press and hold <b>F8</b>.</p> </li> </ul>
--------------------------------	--



## ■ Entering Password

<p>Even after entering the password, password input screen is displayed again.</p>	<ul style="list-style-type: none"> <li>● The computer may be in ten-key mode. If the NumLk indicator  lights, press <b>NumLk</b> to disable the ten-key mode, and then input.</li> <li>● The computer may be in Caps Lock mode. If the Caps Lock indicator  lights, press <b>Caps Lock</b> to disable the Caps Lock mode, and then input.</li> </ul>
<p>Cannot log on to Windows. (“The user name or password is incorrect.” is displayed.)</p>	<ul style="list-style-type: none"> <li>● The user name (account name) includes the “@” mark. If another user account name exists: Log on to Windows using another user account, and delete the account name that includes “@”. Then create a new account. If no other account name exists: You need to reinstall Windows (→ page 23).</li> </ul>

## ■ Shutting down

<p>Windows does not shut down.</p>	<ul style="list-style-type: none"> <li>● Remove the USB device and the ExpressCard.</li> <li>● Wait one or two minutes. It is not a malfunction.</li> </ul>
------------------------------------	---

## ■ Display

<p>No display.</p>	<ul style="list-style-type: none"> <li>● The external display is selected. Press <b>Fn + F3</b> or  + <b>P</b> to switch the display. Wait until the display has been switched completely before pressing <b>Fn + F3</b> or  + <b>P</b> again.</li> <li>● When using an external display,             <ul style="list-style-type: none"> <li>• Check the cable connection.</li> <li>• Turn on the display.</li> <li>• Check the settings of external display.</li> </ul> </li> <li>● The display is turned off by the power-saving function. To resume, do not press the direct selection keys, but press any other key like <b>Ctrl</b>.</li> <li>● The computer entered sleep or hibernation by the power-saving function. To resume, press the power switch.</li> </ul>
--------------------	--

# Troubleshooting (Basic)

## ■ Display

The screen is dark.	<ul style="list-style-type: none"> <li>● The screen is darker when the AC adaptor is not connected. Press <b>Fn + F2</b> and adjust the brightness. As you increase the brightness, battery consumption increases. You can separately set the brightness for when the AC adaptor is connected and when not connected.</li> <li>● Press <b>Fn + F8</b> to turn off the concealed mode.</li> </ul>
The screen is disordered.	<ul style="list-style-type: none"> <li>● Changing the number of display colors and resolution may affect the screen. Restart the computer.</li> <li>● Connecting/disconnecting an external display may affect the screen. Restart the computer.</li> <li>● Resuming from sleep or hibernation may affect the screen of the external display. Restart the computer.</li> </ul>
During Simultaneous display, one of the screens becomes disordered.	<ul style="list-style-type: none"> <li>● When using the Extended Desktop, use the same display colors for the external display as those used by the LCD.</li> <li>● Simultaneous display cannot be used until Windows startup is complete (during Setup Utility, etc.).</li> </ul>
The external display does not work normally.	<ul style="list-style-type: none"> <li>● If the external display does not support the power saving function, it may not work normally when the computer enters the power saving mode. Turn off the external display.</li> </ul>

## ■ Touch Pad / Touchscreen (only for model with touchscreen)

The cursor does not work.	<ul style="list-style-type: none"> <li>● When using the external mouse, connect it correctly.</li> <li>● Restart the computer using the keyboard.</li> <li>● If the computer does not respond to keyboard commands, read "No response" (→ page 31).</li> </ul>
Cannot input using the touch pad.	<ul style="list-style-type: none"> <li>● Set [Touch Pad] to [Enabled] in the [Main] menu of the Setup Utility.</li> <li>● The drivers for some mice may disable the touch pad. Check your mouse's operating instructions.</li> </ul>
<Only for model with touch screen> Cannot input using the touchscreen.	<ul style="list-style-type: none"> <li>● Set [Touchscreen Mode] to [Auto] or [Tablet] in the [Main] menu of the Setup Utility.</li> <li>● Set [Touchscreen] to [Enabled] in the [Advanced] menu of the Setup Utility.</li> </ul>
Cannot point the correct position using the included stylus.	<ul style="list-style-type: none"> <li>● Perform the touchscreen calibration (→  <i>Reference Manual</i> "Screen Input Operation").</li> </ul>
<b>Windows 8</b> <Only for model with touch-screen> "Charm" does not always appear by finger operation.	<ul style="list-style-type: none"> <li>● Flick toward the center of the screen from the right edge.</li> <li>● Use the included pen.</li> </ul>

## ■ On-screen Document

<b>Windows 7</b> The document of PDF format is not displayed.	<ul style="list-style-type: none"> <li>● Install Adobe Reader.             <ol style="list-style-type: none"> <li>① Log on to Windows as an administrator.</li> <li>② Click  (Start) and input "c:\util\reader\en\Pinstall.bat" in [Search programs and files] then press <b>Enter</b>.</li> <li>③ Update Adobe Reader to its latest version. If your computer is connected to the internet, start up Adobe Reader and click [Help] - [Check for Updates...].</li> </ol> </li> </ul>
--	---

## ■ CD/DVD Drive

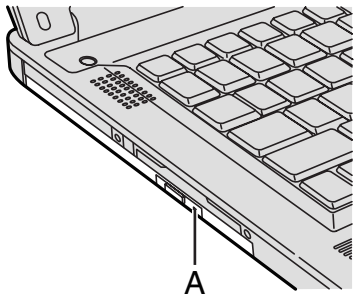
<p>The tray does not come out although inserting a pointed object to the emergency hole.</p>	<ul style="list-style-type: none"> <li>● A pin of 1.3 mm in diameter is recommended to remove a disc using the emergency hole (A). When the diameter of the pin is smaller than this, insert the pin slightly downward.</li> </ul>	
--	--	---

## ■ Others

<p>No response.</p>	<ul style="list-style-type: none"> <li>● Press <b>Ctrl+Shift+Esc</b> to open Task Manager and close the software application that is not responding.</li> <li>● An input screen (e.g., password input screen at startup) may be hidden behind another window. Press <b>Alt+Tab</b> to check.</li> <li>● Press the power switch for four seconds or longer to shut down the computer, and then press the power switch to turn it on. If the application program does not work normally, uninstall and reinstall the program. To uninstall,             <ol style="list-style-type: none"> <li>① Open the Control Panel.                 <ul style="list-style-type: none"> <li><b>Windows 8</b></li> <li>1. Right-click any empty location on the Start screen.</li> <li>2. Click [All apps] on the app bar.</li> <li>3. Click [Control Panel] under "Windows System".</li> <li><b>Windows 7</b></li> <li>Click  (Start) - [Control Panel].</li> </ul> </li> <li>② Click [Program] - [Uninstall a program].</li> </ol> </li> </ul>
<p>Cannot enter characters correctly.</p>	<ul style="list-style-type: none"> <li>● Select the same language setting for Windows and the internal keyboard (→ page 16).</li> </ul>
<p>The recovery disc for Windows 8 is not functioning.</p>	<ul style="list-style-type: none"> <li>● Perform recovery using the recovery disc for Windows 7 first, and then perform recovery using the recovery disc for Windows 8.</li> </ul>

# LIMITED USE LICENSE AGREEMENT

THE SOFTWARE PROGRAM(S) (“PROGRAMS”) FURNISHED WITH THIS PANASONIC PRODUCT (“PRODUCT”) ARE LICENSED ONLY TO THE END-USER (“YOU”), AND MAY BE USED BY YOU ONLY IN ACCORDANCE WITH THE LICENSE TERMS DESCRIBED BELOW. YOUR USE OF THE PROGRAMS SHALL BE CONCLUSIVELY DEEMED TO CONSTITUTE YOUR ACCEPTANCE OF THE TERMS OF THIS LICENSE.

Panasonic Corporation has developed or otherwise obtained the Programs and hereby licenses their use to you. You assume sole responsibility for the selection of the Product (including the associated Programs) to achieve your intended results, and for the installation, use and results obtained therefrom.

## LICENSE

- A. Panasonic Corporation hereby grants you a personal, non-transferable and non-exclusive right and license to use the Programs in accordance with the terms and conditions stated in this Agreement. You acknowledge that you are receiving only a LIMITED LICENSE TO USE the Programs and related documentation and that you shall obtain no title, ownership nor any other rights in or to the Programs and related documentation nor in or to the algorithms, concepts, designs and ideas represented by or incorporated in the Programs and related documentation, all of which title, ownership and rights shall remain with Panasonic Corporation or its suppliers.
- B. You may use the Programs only on the single Product which was accompanied by the Programs.
- C. You and your employees and agents are required to protect the confidentiality of the Programs. You may not distribute or otherwise make the Programs or related documentation available to any third party, by time-sharing or otherwise, without the prior written consent of Panasonic Corporation.
- D. You may not copy or reproduce, or permit to be copied or reproduced, the Programs or related documentation for any purpose, except that you may make one (1) copy of the Programs for backup purposes only in support of your use of the Programs on the single Product which was accompanied by the Programs. You shall not modify, or attempt to modify, the Programs.
- E. You may transfer the Programs and license them to another party only in connection with your transfer of the single Product which was accompanied by the Programs to such other party. At the time of such a transfer, you must also transfer all copies, whether in printed or machine readable form, of every Program, and the related documentation, to the same party or destroy any such copies not so transferred.
- F. You may not remove any copyright, trademark or other notice or product identification from the Programs and you must reproduce and include any such notice or product identification on any copy of any Program.

YOU MAY NOT REVERSE ASSEMBLE, REVERSE COMPILE, OR MECHANICALLY OR ELECTRONICALLY TRACE THE PROGRAMS, OR ANY COPY THEREOF, IN WHOLE OR IN PART.

YOU MAY NOT USE, COPY, MODIFY, ALTER, OR TRANSFER THE PROGRAMS OR ANY COPY THEREOF, IN WHOLE OR IN PART, EXCEPT AS EXPRESSLY PROVIDED IN THE LICENSE.

IF YOU TRANSFER POSSESSION OF ANY COPY OF ANY PROGRAM TO ANOTHER PARTY, EXCEPT AS PERMITTED IN PARAGRAPH E ABOVE, YOUR LICENSE IS AUTOMATICALLY TERMINATED.

## TERM

This license is effective only for so long as you own or lease the Product, unless earlier terminated. You may terminate this license at any time by destroying, at your expense, the Programs and related documentation together with all copies thereof in any form. This license will also terminate effective immediately upon occurrence of the conditions thereof set forth elsewhere in this Agreement, or if you fail to comply with any term or condition contained herein. Upon any such termination, you agree to destroy, at your expense, the Programs and related documentation together with all copies thereof in any form.

YOU ACKNOWLEDGE THAT YOU HAVE READ THIS AGREEMENT, UNDERSTAND IT AND AGREE TO BE BOUND BY ITS TERMS AND CONDITIONS. YOU FURTHER AGREE THAT IT IS THE COMPLETE AND EXCLUSIVE STATEMENT OF THE AGREEMENT BETWEEN US, WHICH SUPERSEDES ANY PROPOSAL OR PRIOR AGREEMENT, ORAL OR WRITTEN, AND ANY OTHER COMMUNICATIONS BETWEEN US, RELATING TO THE SUBJECT MATTER OF THIS AGREEMENT.



# Specifications

This page provides the specifications for the basic model. The model number is different according to the unit configuration.

- To check the model number:  
Check the bottom of the computer or the box the computer came in at the time of purchase.
- To check CPU speed, memory size and the hard disk drive (HDD) size:  
Run the Setup Utility (→  *Reference Manual* "Setup Utility") and select [Information] menu.  
[Processor Speed]: CPU speed, [Memory Size]: Memory size, [Hard Disk]: Hard disk drive size

## ■ Main Specifications

Model No.	CF-53SAWZYBE	CF-53SSWZYBE	
CPU/Secondary cache memory	Intel® Core™ i5-3340M Processor (3 MB <sup>*1</sup> cache, up to 3.4 GHz) with Intel® Turbo Boost Technology		
Chip Set	Mobile Intel® 7 QM77 Express Chipset		
Video controller	Intel® HD Graphics 4000 (Built-in CPU)		
Main Memory <sup>*2</sup>	4 GB <sup>*1</sup> , DDR3 SDRAM (16 GB <sup>*1</sup> Max.)		
Video Memory <sup>*3</sup>	<b>Windows 8</b> UMA 1664 MB <sup>*1</sup> Max. <b>Windows 7</b> UMA <32-bit> 1416 MB <sup>*1</sup> Max., <64-bit> 1696 MB <sup>*1</sup> Max.		
Hard Disk Drive	500 GB <sup>*4</sup> <b>Windows 8</b> Approx. 20 GB <sup>*4</sup> is used as a partition with HDD recovery tools. (Users cannot use this partition.) Approx. 1 GB <sup>*4</sup> is used as a partition with system tools. (Users cannot use this partition.) <b>Windows 7</b> Approx. 50 GB <sup>*4</sup> is used as a partition with HDD recovery tools. (Users cannot use this partition.) Approx. 300 MB <sup>*4</sup> is used as a partition with system tools. (Users cannot use this partition.)		
CD/DVD Drive	DVD MULTI Drive built-in, Buffer underrun error prevention function: Supported		
Continuous Data Transfer Speed <sup>*5*6</sup>	Reading <sup>*7</sup>	• DVD-RAM <sup>*8</sup> : 5X (Max.) • DVD-R <sup>*9</sup> : 8X (Max.) • DVD-R DL: 8X (Max.) • DVD-RW: 8X (Max.) • DVD-ROM: 8X (Max.) • +R: 8X (Max.) • +R DL: 8X (Max.) • +RW: 8X (Max.) • High Speed +RW: 8X (Max.) • CD-ROM: 24X (Max.) • CD-R: 24X (Max.) • CD-RW: 24X (Max.) • High-Speed CD-RW: 24X (Max.) • Ultra-Speed CD-RW: 24X (Max.)	
		Writing <sup>*10</sup>	• DVD-RAM <sup>*8</sup> : 5X (Max.) • DVD-R <sup>*9</sup> : 8X (Max.) • DVD-R DL: 6X (Max.) • DVD-RW: 6X (Max.) • +R: 8X (Max.) • +R DL: 6X (Max.) • +RW: 4X (Max.) • High Speed +RW: 8X (Max.) • CD-R: 24X (Max.) • CD-RW: 4X • High-Speed CD-RW: 10X • Ultra-Speed CD-RW: 24X (Max.)
	Supported Discs/Format	Reading	• DVD-ROM (Single Layer, Dual Layer) • DVD-Video • DVD-R <sup>*9</sup> (1.4 GB, 3.95 GB, 4.7 GB) <sup>*4</sup> • DVD-R DL (8.5 GB) <sup>*4</sup> • DVD-RW (Ver.1.1/1.2 1.4 GB, 2.8 GB, 4.7 GB, 9.4 GB) <sup>*4</sup> • DVD-RAM <sup>*8</sup> (1.4 GB, 2.6 GB, 2.8 GB, 4.7 GB, 5.2 GB, 9.4 GB) <sup>*4</sup> • +R (4.7 GB) <sup>*4</sup> • +R DL (8.5 GB) <sup>*4</sup> • +RW (4.7 GB) <sup>*4</sup> • High Speed +RW (4.7 GB) <sup>*4</sup> • CD-Audio • CD-ROM (XA compatible) • CD-R • Photo CD (multiple session compatible) • Video CD • CD-EXTRA • CD-RW • CD-TEXT • High-Speed CD-RW • Ultra-Speed CD-RW
		Writing	• DVD-RAM <sup>*8</sup> (1.4 GB, 2.8 GB, 4.7 GB, 9.4 GB) <sup>*4</sup> • DVD-R (1.4 GB, 4.7 GB for General) <sup>*4</sup> • DVD-R DL (8.5 GB) <sup>*4</sup> • DVD-RW (Ver.1.1/1.2 1.4 GB, 2.8 GB, 4.7 GB, 9.4 GB) <sup>*4</sup> • +R (4.7 GB) <sup>*4</sup> • +R DL (8.5 GB) <sup>*4</sup> • +RW (4.7 GB) <sup>*4</sup> • High Speed +RW (4.7 GB) <sup>*4</sup> • CD-R • Photo CD (multiple session compatible) • Video CD • CD-EXTRA • CD-RW • CD-TEXT • High-Speed CD-RW • Ultra-Speed CD-RW, CD-Audio
Display Method	14 type (TFT) (1366 × 768 dots)	14 type with Touchscreen (TFT) (1366 × 768 dots)	
Internal LCD	65,536/16,777,216 colors (800 × 600 dots / 1024 × 768 dots / 1280 × 600 dots / 1280 × 720 dots / 1280 × 768 dots / 1360 × 768 dots / 1366 × 768 dots) <sup>*11</sup>		
External Display <sup>*12</sup>	65,536 / 16,777,216 colors (800 × 600 dots / 1024 × 768 dots / 1280 × 768 dots / 1600 × 1200 dots / 1920 × 1080 dots / 1920 × 1200 dots)		
Wireless LAN <sup>*13</sup>	Intel® Centrino® Advanced-N 6235 (a/b/g/n) / Intel® Centrino® Advanced-N 6205 (a/b/g/n) → page 35		
Bluetooth <sup>*14</sup>	→ page 35		
Wireless WAN <sup>*15</sup>	Equipped		
GPS <sup>*16</sup>	Chip: SiRF starIII Accuracy: 10m (2DRMS), 5m (2RDMS, SBAS) Protocol message: GGA, GSA, GSV, RMC, VTG		
LAN	IEEE 802.3 10Base-T / IEEE 802.3u 100BASE-TX / IEEE 802.3ab 1000BASE-T (2nd LAN <sup>*17</sup> : IEEE 802.3 10BASE-T, IEEE 802.3u 100BASE-TX)		

# Specifications

## ■ Main Specifications

Model No.		CF-53SAWZYBE	CF-53SSWZYBE
Modem <sup>*18</sup>		Data: 56 kbps (V.92) FAX: 14.4 kbps	
Sound		WAVE and MIDI playback, Intel® High Definition Audio subsystem support	
Security Chip		TPM (TCG V1.2 compliant) <sup>*19</sup>	
Card Slots	PC Card Slot	x 1 <sup>*20</sup> or x 2 <sup>*21</sup> , Type I or Type II, Allowable current 3.3 V: 400 mA, 5 V: 400 mA	
	ExpressCard Slot <sup>*22</sup>	x 1, ExpressCard/34 or ExpressCard/54	
	SD Memory Card Slot <sup>*23</sup>	x 1	
	Contact Smart Card Slot <sup>*24</sup>	x 1	
RAM Module Slot		x 1, DDR3L SDRAM, 204-pin, 1.35 V, SO-DIMM, PC3L-10600 Compliant	
Interface		USB Ports x 4 (USB 2.0 x 2 + USB 3.0 x 2) <sup>*25</sup> / Serial Port (Dsub 9-pin male) / Modem Port (RJ-11) <sup>*18</sup> / LAN Port (RJ-45) x 1 <sup>*26</sup> or 2 <sup>*17</sup> / VGA Port (Mini Dsub 15-pin female) / HDMI Port (Type A) <sup>*27</sup> / IEEE1394a Interface Connector (4-pin) <sup>*28</sup> / Microphone Jack (Miniature jack, 3.5 D/A) / Headphone Jack (Miniature jack, 3.5 D/A, Impedance 32 Ω, Output Power 4 mW × 2, Stereo) / Expansion Bus Connector (Dedicated 100-pin female) / Rugged USB 2.0 Port <sup>*29</sup>	
Keyboard / Pointing Device		88 or 87 keys / Touch Pad	88 or 87 keys / Touch Pad, Touchscreen
Fingerprint Reader <sup>*30</sup>		Array Size : 192 x 4 pixels, Image Size : 192 x 512 pixels, Image Resolution : 508 DPI	
RFID Reader <sup>*31</sup>		RF frequency: 13.56 MHz, compatible with ISO14443 Type-A, ISO14443 Type-B	
Camera <sup>*32</sup>		1280 × 720 dots, 30 fps (Video), Monaural Microphone	
Power Supply		AC adaptor or Battery pack	
AC Adaptor <sup>*33</sup>		Input: 100 V - 240 V AC, 50 Hz/60 Hz, Output: 15.6 V DC, 7.05 A	
Battery Pack		Li-ion 10.8 V, Typical 6750 mAh / Minimum 6300 mAh (with CF-VZSU71U) Li-ion 10.8 V, Typical 4500 mAh / Minimum 4200 mAh (with CF-VZSU72U)	
		Operating Time <sup>*34</sup>	Approx. 11 hours (with CF-VZSU71U) Approx. 8 hours (with CF-VZSU72U)
		Charging Time <sup>*35</sup>	Approx. 2 hours
Power Consumption <sup>*36</sup>		Approx. 30 W <sup>*37</sup> / Approx. 100 W (maximum when recharging in the ON state)	
Physical Dimensions (W × D × H) (including the carrying handle)		340 mm × 281 mm × 46 - 55 mm	
Weight (including the hand strap)		Approx. 2.65 kg (with CF-VZSU71U) Approx. 2.55 kg (with CF-VZSU72U)	Approx. 2.95 kg
Environment	Operating	Temperature	<Model without HDD heater> 0 °C to 50 °C (IEC60068-2-1, 2) <sup>*38</sup> <Model with HDD heater> -10 °C to 50 °C (IEC60068-2-1, 2) <sup>*38</sup>
		Humidity	30 to 80 % (No condensation)
	Storage	Temperature	- 20 to 60 °C
		Humidity	30 % to 90 % RH (No condensation)

## ■ Software

Base OS	Windows® 8 Pro 64-bit	Windows7® Professional 32-bit Service Pack 1 / Windows7® Professional 64-bit Service Pack 1
Installed OS <sup>*39</sup>	<b>Windows 8</b> Windows® 8 Pro 64-bit <b>Windows 7</b> Windows7® Professional 32-bit Service Pack 1 (downgraded to Windows® 7) <sup>*40</sup> / Windows7® Professional 64-bit Service Pack 1 (downgraded to Windows® 7) <sup>*40</sup>	Windows7® Professional 32-bit Service Pack 1 / Windows7® Professional 64-bit Service Pack 1



# Specifications

- <sup>\*15</sup> Only for model with wireless WAN. The specifications may differ depending on the model.
- <sup>\*16</sup> Only for model with GPS.
- <sup>\*17</sup> Only for model with 2nd LAN.
- <sup>\*18</sup> Only for model with modem.
- <sup>\*19</sup> Only for model with TPM.  
For information on TPM, refer to the Installation Manual of “Trusted Platform Module (TPM)” by the following procedure.
- Windows 8**  
On the Start screen, click the [Manual Selector] tile, and select “Installation Manual for Trusted Platform Module (TPM)”
- Windows 7**  
Double-click [Manual Selector] on the desktop, and select “Installation Manual for Trusted Platform Module (TPM)”.
- <sup>\*20</sup> Only for model with 1 PC card slot.
- <sup>\*21</sup> Only for model with 2 PC card slots.
- <sup>\*22</sup> Only for model with ExpressCard slot.
- <sup>\*23</sup> This slot is compatible with High-Speed Mode. Operation has been tested and confirmed using Panasonic SD/SDHC/SDXC Memory Cards with a capacity of up to 64 GB. Operation on other SD equipment is not guaranteed.
- <sup>\*24</sup> Only for model with Smart Card slot.
- <sup>\*25</sup> Does not guarantee operation of all USB-compatible peripherals.
- <sup>\*26</sup> Only for model without 2nd LAN.
- <sup>\*27</sup> Does not guarantee operation of all HDMI-compatible peripherals.
- <sup>\*28</sup> Only for model with IEEE 1394a interface.
- <sup>\*29</sup> Only for model with rugged USB 2.0 port.
- <sup>\*30</sup> Only for model with Fingerprint reader.
- <sup>\*31</sup> Only for model with RFID reader.
- <sup>\*32</sup> Only for model with Camera. The specifications may differ depending on the model.
- <sup>\*33</sup> <Only for North America>  
The AC adaptor is compatible with power sources up to 240 V AC adaptor. This computer is supplied with a 125 V AC compatible AC cord. 20-M-2-1
- <sup>\*34</sup> Measured with LCD brightness : 60 cd/m<sup>2</sup>  
Varies depending on the usage conditions, or when an optional device is attached.
- <sup>\*35</sup> Varies depending on the usage conditions, CPU speed, etc.
- <sup>\*36</sup> Approx. 0.5 W when the battery pack is fully charged (or not being charged) and the computer is off.  
<When using with 115 V AC>  
Even when the AC adaptor is not connected to the computer, power is consumed (Max. 0.2 W) simply by having the AC adaptor plugged into an AC outlet.  
<When using with 240 V AC>  
Even when the AC adaptor is not connected to the computer, power is consumed (Max. 0.3 W) simply by having the AC adaptor plugged into an AC outlet.
- <sup>\*37</sup> Rated power consumption. 23-E-1
- <sup>\*38</sup> Do not expose the skin to this product when using the product in a hot or cold environment. (➔ page 4) When using in hot or cold environment, some peripherals may fail to work properly. Check the operation environment of the peripherals. Using this product continuously in a hot environment will shorten the product life. Avoid use in these types of environments. When using in low temperature environment, startup may become slow or battery operation time may become short. The computer consumes power when the hard disk is warming up during startup. Therefore, if you are using battery power and the remaining power is low, the computer may not start up.
- <sup>\*39</sup> Operations of this computer are not guaranteed except for the pre-installed OS and the OS which is installed by using the Recovery disc provided by Panasonic.
- <sup>\*40</sup> This system is preinstalled with Windows® 7 Professional software and also comes with a license for Windows 8 Pro software. You may only use one version of the Windows software at a time. Switching between versions will require you to uninstall one version and install the other version.
- <sup>\*41</sup> Must be installed before use.
- <sup>\*42</sup> Perform on the recovery disc.  
**Windows 7**  
Alternatively perform on the hard disk recovery partition.
- <sup>\*43</sup> To continue using this software after the end of the trial, purchase a license by following the on-screen instructions.
- <sup>\*44</sup> These are speeds specified in IEEE802.11a+b+g+n standards. Actual speeds may differ.
- <sup>\*45</sup> Available when set to “WPA-PSK”, “WPA2-PSK” or “none”.
- <sup>\*46</sup> Only available when HT40 enabled by the computer.

# Standard Limited Warranty

## Panasonic System Communications Company Europe

Panasonic System Communications Company Europe (referred to as "Panasonic") will repair this product (other than software, which is treated in a different section of this warranty) with new or refurbished parts, from the date of original purchase in the event of a defect in materials or workmanship. This warranty only applies to new Panasonic Toughbooks purchased in the EEA and Switzerland and Turkey.

Panasonic (or its authorised Service Provider) target to repair your equipment within 48 hours from its receipt in our service centre.

Additional charges may apply for shipment to countries outside of the European Union. Panasonic will use all reasonable endeavours to ensure this service.

This warranty only covers failures due to defects in materials or workmanship which occur during normal use for the applicable Service Agreement Period listed below. In the event that any product (or part thereof) is replaced, Panasonic shall transfer ownership of the replacement product (or part) to the customer and the customer shall transfer ownership of the replaced product (or part) to Panasonic.

### Service Agreement Period - from original date of purchase

- Toughbooks (and every accessory included in the original packaging except the battery) - 3 years
- Toughpads (and every accessory included in the original packaging except the battery) - 3 years
- Accessories included in the original package - 3 years
- Additional peripherals manufactured by Panasonic (including media bay devices such as CD-Rom drives) - 1 year
- Batteries - 6 months. Panasonic Warranty covers the battery for six months. A battery is considered good if it maintains 50% of its charge capacity during the warranty period. If a battery is returned under this contract and testing determines that it has charge capacity greater than 50%, the battery will be returned with an invoice for the retail purchase price of a new battery.

This warranty is extended solely to the original purchaser. A purchase receipt or other proof of date of original purchase will be required before warranty performance is rendered.

### Limits and Exclusions:

This warranty does not cover and shall be void for:

- Broken or cracked LCD screen.
- Defective pixel in notebook displays and LCD screens within 0.002%
- Damage that is attributable to fire, theft or acts of God.
- Damage caused by environmental influences (electrical storms, magnetic fields etc.).
- Damage which has not been caused during normal operation
- Repair of damage that is cosmetic only or does not affect product functionality such as wear and tear, scratches and dents.
- Failures caused by products not supplied by Panasonic.
- Failures resulting from alteration, accidental damage, casualty, misuse, abuse or neglect.
- Introduction of liquid or other foreign matter into the unit.
- Improper installation, operation or maintenance.
- Improper connections with peripherals.
- Maladjustment of consumer controls such as function settings.
- Modification or service by anyone other than Panasonic or its approved Service Providers.
- Products used as short term rental or leased equipment.
- Products whose serial number has been removed making the unit warranty condition impossible to clearly determine.

THIS PRODUCT IS NOT INTENDED FOR USE AS, OR AS PART OF, NUCLEAR EQUIPMENT/SYSTEMS, AIR TRAFFIC CONTROL EQUIPMENT/SYSTEMS, OR AIRCRAFT COCKPIT EQUIPMENT/SYSTEMS. PANASONIC WILL NOT BE RESPONSIBLE FOR ANY LIABILITY RESULTING FROM THE USE OF THIS PRODUCT ARISING OUT OF THE FOREGOING USES.

There are no other express warranties except as listed above.

We strongly recommend that customers backup their data before sending back their unit to an Authorised Service Provider.

Panasonic shall not be liable for loss of data or other incidental or consequential damages resulting from the use of this product, or arising out of any breach of this warranty. All express and implied warranties, including the warranties of satisfactory quality and fitness for a particular purpose are limited to the applicable warranty period set forth above. Panasonic shall not be liable for any indirect, special or consequential loss or damage (including without limitation any loss of profits) arising from the use of this product or for any breach of this warranty.

This limited warranty gives you specific legal rights, and you may have other rights that vary from country to country. You must consult the applicable country laws for a full determination of your rights. This limited warranty is in addition to, and does not affect any rights arising out of any contract of sale or by statute.



# Standard Limited Warranty

## Panasonic System Communications Company Europe

### Data Storage Media

Data Storage Media is the media on which the Operating System, drivers and programs originally installed by Panasonic on the main unit are stored. This media is originally provided with the unit.

Panasonic warrants to you only that the disc(s) or other media on which the Programs are furnished will be free from defects in material and workmanship under normal use for a period of sixty (60) days from the date of delivery thereof to you, as evidenced by your purchase receipt.

This is the only warranty Panasonic makes to you. Panasonic does not warrant that the functions contained in the Programs will meet your requirements or that the operation of the Programs will be uninterrupted or error free.

Panasonic's entire liability and your exclusive remedy under this warranty shall be limited to the replacement of any defective disk or other media which is returned to Panasonic's authorized Service Centre, together with a copy of the purchase receipt, within the aforesaid warranty period.

Panasonic shall have no obligation for any defects in the disk(s) or other media on which the Programs are furnished resulting from your storage thereof, or for defects that have been caused by operation of the disk(s) or other media otherwise than on the Product or in the environment conditions other than those specified by Panasonic by alteration, accident, misuse, abuse, neglect, mishandling, misapplication, installation, maladjustment of consumer controls, improper maintenance, modification or damage that is attributable to acts of God. In addition, Panasonic shall have no obligation for any defects in the disk(s) or other media if you have modified, or attempted to modify any Program.

Duration of implied warranties, if any is limited to sixty (60) days.

### Pre-installed software

Pre-installed software means the software shipped pre-loaded by Panasonic, not that loaded by any third party or selling agent.

Panasonic and its suppliers makes no warranty, either express, implied or statutory, with respect to software provided with the Product and licensed to Purchaser, its quality, performance, merchantability, or fitness for a particular purpose. Panasonic does not warrant that the functions contained in the software will be uninterrupted or error free. Panasonic assumes no risk of and shall not in any case be liable for any damages, including, without limitation, any special, incidental, consequential, or punitive damages arising from breach of warranty or contract, negligence or any other legal theory, including, without limitation loss of goodwill, profits or revenue, loss of use of the Programs or Products or any associated equipment, cost of capital, cost of any substitute equipment, facilities, or services, downtime costs, or claims of any party dealing with such damages.

Some countries do not allow the exclusion or limitation of incidental or consequential damages, or limitations on how long an implied warranty lasts, so the above limitations or exclusions may not apply to you.

This limited warranty gives you specific legal rights and you may also have other rights that vary from country to country. You must consult applicable country laws for a full determination of your rights.

## Contacts

### Address

Panasonic System Communications Company Europe  
Panasonic Manufacturing U.K. Ltd.  
Service Centre Building B4,  
Wyncliffe Road, Pentwyn Industrial Estate, Cardiff,  
United Kingdom  
CF23 7XB

### Web page

<http://www.toughbook.eu/>

### Helpdesk

English speaking service  
French speaking service  
German speaking service  
Italian speaking service  
Spanish speaking service  
E-mail address

+44 (0) 8709 079 079  
+33 (0) 1 55 93 66 60  
+49 (0) 1805 410 930  
+39 (0) 848 391 999  
+34 (0) 901 101 157  
[toughbooksupport@eu.panasonic.com](mailto:toughbooksupport@eu.panasonic.com)

Czech speaking service  
Hungarian speaking service  
Polish speaking service  
Romanian speaking service  
Slovakian speaking service  
E-mail address

+420 (0) 800 143234  
+36 (0) 6800 163 67  
+48 (0) 800 4911558  
+40 (0) 800 894 743  
+421 (0) 800 42672627  
[toughbooksupport@csg.de](mailto:toughbooksupport@csg.de)

Payments

[toughbookservicepayments.cardiff@eu.panasonic.com](mailto:toughbookservicepayments.cardiff@eu.panasonic.com)







As an ENERGY STAR® Partner, Panasonic Corporation has determined that this product meets ENERGY STAR® guidelines for energy efficiency. By enabling available power management settings, Panasonic computers enter a low-power sleep mode after a period of inactivity, saving the user energy.

**Outline of the International ENERGY STAR® Office Equipment Program**

The international ENERGY STAR® Office Equipment Program is an international program that promotes energy saving through the use of computers and other office equipment. The program backs the development and dissemination of products with functions that effectively reduce energy consumption. It is an open system in which business proprietors can participate voluntarily. The targeted products are office equipment such as computers, displays, printers, facsimiles, and copiers. Their standards and logos are uniform among participating nations.

22-E-1

---

**Panasonic Corporation**  
Osaka, Japan

Importer's name & address pursuant to the EU legislation

**Panasonic System Communications Company Europe, Panasonic Marketing Europe GmbH**  
Hagenauer Straße 43  
65203 Wiesbaden  
Germany

© Panasonic Corporation 2013  
Printed in UK

UK0813-1113  
CPE02778ZB