



Panasonic®

Personal Computer

Model No. **CF-31** series

Operating Instructions - Read Me First

Read Me First

Safety Precautions	2
Regulatory Information	6

Getting Started

First-time Operation.....	11
---------------------------	----

Read Me First

Getting Started

Refer to the *OPERATING INSTRUCTIONS - Basic Guide* by downloading from the following URL.
URL > http://pc-dl.panasonic.co.jp/itn/manual/menu_en.html

Please read these instructions carefully before using this product, and save this manual for future use.

Safety Precautions

To reduce the risk of injury, loss of life, electric shock, fire, malfunction, and damage to equipment or property, always observe the following safety precautions.

Explanation of symbol word panels

The following symbol word panels are used to classify and describe the level of hazard, injury, and property damage caused when the denotation is disregarded and improper use is performed.

DANGER

Denotes a potential hazard that will result in serious injury or death.

WARNING

Denotes a potential hazard that could result in serious injury or death.



CAUTION

Denotes a hazard that could result in minor injury.

NOTICE

Denotes a hazard that could result in property damage.

The following symbols are used to classify and describe the type of instructions to be observed.

	This symbol is used to alert users to a specific operating procedure that must not be performed.
	This symbol is used to alert users to a specific operating procedure that must be followed in order to operate the unit safely.

DANGER

Electrolyte leakage, generation of heat, ignition or rupture of the Battery Pack may result.



- **Do Not Throw the Battery Pack into a Fire or Expose It to Excessive Heat**
- **Do Not Deform, Disassemble, or Modify the Battery Pack**
- **Do Not Short the Positive (+) and Negative (-) Contacts**
 - ⇒ Do not place the battery pack together with articles such as necklaces or hairpins when carrying or storing.
- **Do Not Apply Shocks to the Product by Dropping It, Applying Strong Pressure to It, etc.**
 - ⇒ If this product is subjected to a strong impact, damaged or deformed, stop using it immediately.
- **Do Not Charge the Battery Using Methods Other Than Those Specified**
- **Do Not Use the Battery Pack with Any Other Product**
 - The battery pack is rechargeable and was intended for the specified product.
- **Do Not Use This Product with a Battery Pack Other Than the One Specified**
 - ⇒ Use only the specified battery pack with your product.



- **Avoid Extreme Heat (Near the Fire, in Direct Sunlight, for Example)**
- **When the Battery Pack Has Deteriorated, Replace It With a New One**
 - ⇒ Do not continue to use a damaged battery pack.

WARNING

Fire or electric shock may result.



- **Do Not Do Anything That May Damage the AC Cord, the AC Plug, or the AC Adaptor**
Do not damage or modify the cord, place it near hot tools, bend, twist, or pull it forcefully, place heavy objects on it, or bundle it tightly.
⇒ Do not continue to use a damaged AC cord, AC plug and AC adaptor.
 - Contact your technical support office for repair.
- **Do Not Connect the AC Adaptor to a Power Source Other Than a Standard Household AC Outlet**
⇒ Connecting to a DC/AC converter (inverter) may damage the AC adaptor. On an airplane, only connect the AC adaptor/charger to an AC outlet specifically approved for such use.
- **Do Not Pull or Insert the AC Plug If Your Hands Are Wet**
- **Do Not Disassemble This Product**
- **Do Not Touch This Product In a Thunderstorm If Connected with the AC Cable or Any Other Cables**
- **Do Not Place Containers of Liquid or Metal Objects on Top of This Product**
⇒ If foreign matter has found its way inside, immediately turn the power off and unplug the AC plug (and remove the battery pack). Then contact your technical support office.



- **If a Malfunction or Trouble Occurs, Immediately Stop Use**
If the Following Malfunction Occurs, Immediately Unplug the AC Plug (and the Battery Pack)
 - This product is damaged
 - Foreign object inside this product
 - Smoke emitted
 - Unusual smell emitted
 - Unusually hot
 ⇒ After the above procedure, contact your technical support office for repair.
- **Clean Dust and Other Debris of the AC Plug Regularly**
 - If dust or other debris accumulates on the plug, humidity, etc. may cause a defect in the insulation.
- **Insert the AC Plug Completely**
⇒ Do not use a damaged plug or loose AC outlet.
- **Close the Connector Cover Tightly When Using This Product Where Is a Lot of Water, Moisture, Steam, Dust, Oily Vapors, etc.**
⇒ If foreign matter has found its way inside, immediately turn the power off and unplug the AC cord, and then remove the battery pack. Then contact your technical support office.

Burns or low-temperature burns may result.



- **Do Not Use This Product in Close Contact With Your Body For a Long Period of Time**
⇒ Do not use this product with its heat-emitting parts in close contact with your body for long periods of time.
 - Low-temperature burns may result.
- **Do Not Expose Yourself or Other Persons to the Hot Wind from the Ventilation Hole (Exhaust) For a Long Period of Time.**
 - Covering the ventilation hole (exhaust) with your hand or other object can cause heat to build up inside, possibly resulting in burns.
- **Do Not Touch The Surface of The AC Adaptor Continuously While Using/Charging**
 - Burns may result.

Detrimental health effects on your body may result.



- **Do Not Turn the Volume Up To Loud When Using Headphones**
 - Listening at high volumes that overstimulate the ear for long periods of time may result in loss of hearing.

CAUTION

Fire or electric shock may result.



- **Do Not Move This Product While the AC Plug Is Connected**
⇒ If the AC cord is damaged, unplug the AC plug immediately.
- **Do Not Connect a Telephone Line, or a Network Cable Other Than the One Specified, Into the LAN Port**
⇒ Do not connect to a network such as the ones listed below.
 - Networks other than 1000BASE-T, 100BASE-TX or 10BASE-T
 - Phone lines (IP phone (Internet Protocol Telephone), Telephone lines, internal phone lines (on-premise switches), digital public phones, etc.)
- **Do Not Subject the AC Adaptor To Any Strong Impact**
⇒ Do not continue to use the AC adaptor after a strong impact such as being dropped.
⇒ Contact your technical support office for repair.
- **Do Not Leave This Product in High Temperature Environment for a Long Period of Time**
 - Leaving this product where it will be exposed to extremely high temperatures such as near fire or in direct sunlight may deform the cabinet and/or cause trouble in the internal parts.
- **Do Not Block the Ventilation Hole (Exhaust/Intake)**
⇒ Do not use this product wrapped in cloth or on top of bedding or a blanket.

Safety Precautions

CAUTION

Fire or electric shock may result.



- **Hold the Plug When Unplugging the AC Plug**
- **Use Only the Specified AC Adaptor With This Product**
 - ⇒ Do not use an AC adaptor other than the one supplied (supplied with the unit or one sold separately as an accessory).
- **Use the Modem With a Regular Telephone Line**
 - ⇒ Do not connect to the following lines.
 - An internal phone line (on-premise switches) of a company or business office
 - A digital public phone
 - Line in a country or area not supported by this product.

This product may fall over or drop, resulting in an injury.



- **Do Not Place This Product on Unstable Surfaces**



- **Avoid Stacking**

Detrimental health effects on your body may result.



- **Take a Break Of 10-15 Minutes Every Hour**
 - Using this product for long periods of time may have detrimental health effects on the eyes or hands.

Burns, low-temperature burns, or frostbite may result.



- **Do Not Expose the Skin To This Product When Using the Product In A Hot Or Cold Environment.**
 - ⇒ When it is necessary to expose the skin to this product such as to scan a fingerprint, perform the operation in the shortest time possible.

NOTICE

- Do not place the computer near a television or radio receiver.
- Keep the computer away from magnets. Data stored on the hard disk may be lost.
- This computer is not intended for the display of images for use in medical diagnosis.
- This computer is not intended for a use with connection of medical equipment for the purpose of medical diagnosis.
- Panasonic shall not be liable for loss of data or other incidental or consequential damages resulting from the use of this product.
- Do not touch the terminals on the battery pack. The battery pack may no longer function properly if the contacts are dirty or damaged.
- Do not expose the battery pack to water, or allow it to become wet.
- If the battery pack will not be used for a long period of time (a month or more), charge or discharge (use) the battery pack until the remaining battery level becomes 30% to 40% and store it in a cool, dry place.
- This computer prevents overcharging of the battery by recharging only when the remaining power is less than approx. 95% of capacity.
- The battery pack is not charged when the computer is first purchased. Be sure to charge it before using it for the first time. When the AC adaptor is connected to the computer, charging begins automatically.
- Should the battery leak and the fluid get into your eyes, do not rub your eyes. Immediately flush your eyes with clear water and see a doctor for medical treatment as soon as possible.

THIS PRODUCT IS NOT INTENDED FOR USE AS, OR AS PART OF, NUCLEAR EQUIPMENT/SYSTEMS, AIR TRAFFIC CONTROL EQUIPMENT/SYSTEMS, AIRCRAFT COCKPIT EQUIPMENT/SYSTEMS, MEDICAL DEVICES OR ACCESSORIES¹, LIFE SUPPORT SYSTEMS OR OTHER EQUIPMENTS/DEVICES/SYSTEMS THAT ARE INVOLVED WITH ENSURING HUMAN LIFE OR SAFETY. PANASONIC WILL NOT BE RESPONSIBLE FOR ANY LIABILITY RESULTING FROM THE USE OF THIS PRODUCT ARISING OUT OF THE FOREGOING USES.

¹ As defined by the European Medical Device Directive (MDD) 93/42/EEC.

Panasonic cannot guarantee any specifications, technologies, reliability, safety (e.g. Flammability/Smoke/Toxicity/Radio Frequency Emission, etc) requirements related to aviation standards and medical equipment standards that differ from the specifications of our COTS (Commercial-Off-The-Shelf) products.

Panasonic cannot guarantee any specifications, technologies, reliability, safety (e.g. Flammability/Smoke/Toxicity/Radio Frequency Emission, etc) requirements related to aviation standards that exceed the specifications of our COTS (Commercial-Off-The-Shelf) products.



This computer is not intended for use in medical equipment including life-support systems, air traffic control systems, or other equipment, devices or systems that are involved with ensuring human life or safety. Panasonic cannot be held responsible in any way for any damages or loss resulting from the use of this unit in these types of equipment, devices or systems, etc.

The CF-31 was developed based on thorough research into the real-world portable computing environments. Exhaustive pursuit of usability and reliability under harsh conditions led to innovations such as the magnesium alloy exterior, vibration damped hard disk drive and floppy disk drive, flexible internal connections. The CF-31's outstanding engineering has been tested using the strict MIL-STD- 810F (for vibration and shock) and IP (for dust and water) based procedures.

As with any portable computer device precautions should be taken to avoid any damage. The following usage and handling procedures are recommended.

Before putting the computer away, be sure to wipe off any moisture.

NOTE

- The battery pack may become warm during recharging or normal use. This is completely normal.
- Recharging will not commence if internal temperature of the battery pack is outside of the allowable temperature range (0 °C to 50 °C).
(→  *Reference Manual* "Battery Power") Once the allowable range requirement is satisfied, charging begins automatically. Note that the recharging time varies based on the usage conditions. (Recharging takes longer than usual when the temperature is 10 °C or below.)
- If the temperature is low, the operating time is shortened. Only use the computer within the allowable temperature range.
- This computer has a high temperature mode function that prevents the degradation of the battery in high temperature environments. (→  *Reference Manual* "Battery Power") A level corresponding to a 100% charge for high temperature mode is approximately equivalent to an 80% charge level for normal temperature mode.
- The battery pack is a consumable item. If the amount of time the computer can be run by using a particular battery pack becomes dramatically shorter and repeated recharging does not restore its performance, the battery pack should be replaced with a new one.
- When transporting a spare battery inside a package, briefcase, etc., it is recommended that it be placed in a plastic bag so that its contacts are protected.
- Always power off the computer when it is not in use. Leaving the computer on when the AC adaptor is not connected will exhaust the remaining battery capacity.

Regulatory Information

Important Safety Instructions

<Only for model with modem>

When using your telephone equipment, basic safety precautions should always be followed to reduce the risk of fire, electric shock and injury to persons, including the following:

1. Do not use this product near water, for example, near a bath tub, wash bowl, kitchen sink or laundry tub, in a wet basement or near a swimming pool.
2. Avoid using a telephone (other than a cordless type) during an electrical storm. There may be a remote risk of electric shock from lightning.

3. Do not use the telephone to report a gas leak in the vicinity of the leak.
4. Use only the power cord and batteries indicated in this manual. Do not dispose of batteries in a fire. They may explode. Check with local codes for possible special disposal instructions.

SAVE THESE INSTRUCTIONS

19-E-1

Information to the User

<Only for model with wireless LAN/Bluetooth>

This product and your Health

This product, like other radio devices, emits radio frequency electromagnetic energy. The level of energy emitted by this product however is far much less than the electromagnetic energy emitted by wireless devices like for example mobile phones. Because this product operates within the guidelines found in radio frequency safety standards and recommendations, we believe this product is safe for use by consumers. These standards and recommendations reflect the consensus of the scientific community and result from deliberations of panels and committees of scientists who continually review and interpret the extensive research literature.

In some situations or environments, the use of this product may be restricted by the proprietor of the building or responsible representatives of the organization. These situations may for example include:

- Using this product on board of airplanes, or
 - In any other environment where the risk of interference to other devices or services is perceived or identified as harmful.
- If you are uncertain of the policy that applies on the use of wireless devices in a specific organization or environment (e.g. airports), you are encouraged to ask for authorization to use this product prior to turning on the product.

Regulatory Information

We are not responsible for any radio or television interference caused by unauthorized modification of this product. The correction of interference caused by such unauthorized modification will be the responsibility of the user. We and its authorized resellers or distributors are not liable for damage or violation of government regulations that may arise from failing to comply with these guidelines.

26-M-1

Regulations for Wireless LAN / Bluetooth

Country / Region	802.11a	802.11b/g Bluetooth
Austria, Belgium, Croatia, Cyprus, Czech Republic, Denmark, Estonia, Finland, France, Germany, Greece, Hungary, Iceland, Ireland, Latvia, Lithuania, Macedonia, Malta, Netherlands, Poland, Portugal, Slovakia, Slovenia, Spain, Sweden, Switzerland, United Kingdom	Restricted to indoor use.	
Italy	Restricted to indoor use. General authorization required if used outside.	General authorization required if used outside of own premises.
Norway	Restricted to indoor use.	Prohibited within a 20 km radius from the centre of Ny-Ålesund.

- The latest version of "ERC RECOMMENDATION 70-03" by European Radiocommunications Committee and the regulation in Turkey.
- Use only the antenna specified by Panasonic.
- Confirm the latest information to the radio regulation authorities.

40-E-1

Lithium Battery

Lithium Battery!

This computer contains a lithium battery to enable the date, time, and other data to be stored. The battery should only be exchanged by authorized service personnel.

Warning!

A risk of explosion from incorrect installation or misapplication may possibly occur.

15-E-1

For Used in Motor Vehicle

Warning: Check the following Commission Recommendation to determine proper installation and usage of this product while operating within a motor vehicle.

“Commission Recommendation on safe and efficient in-vehicle information and communication systems: A European statement of principles on human machine interface.”

Commission Recommendation is available from Official Journal of the European Communities.

35-E-1

When using Port Replicator or Car Mounter on which an external antenna can be installed:

- External antenna for wireless LAN must be professionally installed.
- The gain of external antenna for wireless LAN must not exceed 5dBi.
- The user must maintain minimum of 20 cm spacing between the external antenna and all people (excluding extremities of hands, wrist and feet) during wireless modes of operation.

41-E-1-1

CD/DVD Drive Caution

CAUTION!

THIS PRODUCT UTILIZES A LASER.

USE OF CONTROLS, ADJUSTMENTS OR PERFORMANCE OF PROCEDURES OTHER THAN THOSE SPECIFIED HEREIN MAY RESULT IN HAZARDOUS RADIATION EXPOSURE.

DO NOT OPEN COVERS AND DO NOT REPAIR YOURSELF.

REFER SERVICING TO QUALIFIED PERSONNEL.

12-E-1

Laser safety information is appropriate only when drive with laser is installed.

12-M-2-1

Information for Users on Collection and Disposal of Old Equipment and used Batteries



These symbols on the products, packaging, and/or accompanying documents mean that used electrical and electronic products and batteries should not be mixed with general household waste. For proper treatment, recovery and recycling of old products and used batteries, please take them to applicable collection points, in accordance with your national legislation and the Directives 2002/96/EC and 2006/66/EC. By disposing of these products and batteries correctly, you will help to save valuable resources and prevent any potential negative effects on human health and the environment which could otherwise arise from inappropriate waste handling. For more information about collection and recycling of old products and batteries, please contact your local municipality, your waste disposal service or the point of sale where you purchased the items. Penalties may be applicable for incorrect disposal of this waste, in accordance with national legislation.



For business users in the European Union

If you wish to discard electrical and electronic equipment, please contact your dealer or supplier for further information.

[Information on Disposal in other Countries outside the European Union]

These symbols are only valid in the European Union. If you wish to discard this product, please contact your local authorities or dealer and ask for the correct method of disposal.



Note for the battery symbol (bottom two symbol examples):

This symbol might be used in combination with a chemical symbol. In this case it complies with the requirement set by the Directive for the chemical involved.

53-E-1

Regulatory Information

Safety Precautions

<Only for model with wireless WAN>

The following safety precautions must be observed during all phases of the operation, usage, service or repair of any Personal Computer or Handheld Computer incorporating wireless WAN modem. Manufacturers of the cellular terminal are advised to convey the following safety information to users and operating personnel and to incorporate these guidelines into all manuals supplied with the product. Failure to comply with these precautions violates safety standards of design, manufacture and intended use of the product. Panasonic assumes no liability for customer failure to comply with these precautions.



When in a hospital or other health care facility, observe the restrictions on the use of mobiles. Switch Personal Computer or Handheld Computer incorporating wireless WAN modem off, if instructed to do so by the guidelines posted in sensitive areas. Medical equipment may be sensitive to RF energy.

The operation of cardiac pacemakers, other implanted medical equipment and hearing aids can be affected by interference from Personal Computer or Handheld Computer incorporating wireless WAN modem placed close to the device. If in doubt about potential danger, contact the physician or the manufacturer of the device to verify that the equipment is properly shielded. Pacemaker patients are advised to keep their Personal Computer or Handheld Computer incorporating wireless WAN modem away from the pacemaker, while it is on.



Switch off Personal Computer or Handheld Computer incorporating wireless WAN modem before boarding an aircraft. Make sure it cannot be switched on inadvertently. The operation of wireless appliances in an aircraft is forbidden to prevent interference with communications systems. Failure to observe these instructions may lead to the suspension or denial of cellular services to the offender, legal action, or both.

For details on usage of this unit in aircrafts please consult and follow instruction provided by the airline.



Do not operate Personal Computer or Handheld Computer incorporating wireless WAN modem in the presence of flammable gases or fumes. Switch off the cellular terminal when you are near petrol stations, fuel depots, chemical plants or where blasting operations are in progress. Operation of any electrical equipment in potentially explosive atmospheres can constitute a safety hazard.



Your Personal Computer or Handheld Computer incorporating wireless WAN modem receives and transmits radio frequency energy while switched on. Remember that interference can occur if it is used close to TV sets, radios, computers or inadequately shielded equipment. Follow any special regulations and always switch off Personal Computer or Handheld Computer incorporating wireless WAN modem wherever forbidden, or when you suspect that it may cause interference or danger.



Road safety comes first! Do not use a Personal Computer or Handheld Computer incorporating wireless WAN modem while driving a vehicle. Do not place the computer with wireless WAN modem in an area where it could cause personal injury to the driver or passengers. It is recommended to stow the unit in the boot or secure stowage area while driving.

Do not place the computer with wireless WAN modem in an area over an air bag or in the vicinity where an air bag may deploy.

Air bags inflate with great force and if the computer with wireless WAN modem is placed in the air bag deployment area may be propelled with great force and cause serious injury to occupants of the vehicle.



IMPORTANT!

Personal Computer or Handheld Computer incorporating wireless WAN modem operate using radio signals and cellular networks cannot be guaranteed to connect in all conditions. Therefore, you should never rely solely upon any wireless device for essential communications, for example emergency calls.

Remember, in order to make or receive calls, Personal Computer or Handheld Computer incorporating wireless WAN modem must be switched on and in a service area with adequate cellular signal strength.

Some networks do not allow for emergency calls if certain network services or phone features are in use (e.g. lock functions, fixed dialing etc.). You may need to deactivate those features before you can make an emergency call.

Some networks require that a valid SIM card be properly inserted in Personal Computer or Handheld Computer incorporating wireless WAN modem.

Interface Cable

Use of an interface cable longer than 3 m (9.84 feet) is not recommended.

11-E-1

CAUTION:

Risk of Explosion if Battery is replaced by an Incorrect Type.

Dispose of Used Batteries According to the Instructions.

58-E-1

Models for Europe

<Only for model with a “CE Ⓞ” mark on the bottom of the computer>

Declaration of Conformity (DoC)



“Hereby, Panasonic declares that this Personal Computer is in compliance with the essential requirements and other relevant provisions of the Directive 1999/5/EC.”

Hint:

If you want to get a copy of the original DoC of our above mentioned products, please contact our web address: <http://www.ptc.panasonic.eu>

Authorised Representative:

Panasonic Testing Centre
Panasonic Marketing Europe GmbH
Winsbergring 15, 22525 Hamburg, Germany

Network connection of Wired Modem.

The terminal equipment is intended for connection to the following public network;

In all the countries of European Economical Area and Turkey;

- Public Switched Telephony Networks

Technical Features of Wired Modem.

The terminal equipment includes the following features;

- DTMF dialing
- Maximum bitrate receiving mode: 56 kbit/s
- Maximum bitrate sending mode: 33.6 kbit/s

Indication of the countries where WLAN is intended to be used:

AT BE BG CH CY CZ DE DK EE ES
FI FR GB GR HR HU IE IS IT LT LU
LV MT NL NO PL PT RO SE SI SK TR

18-25-E-1

This equipment requires minimum 20 cm spacing from all person's body (excluding extremities of hands, wrist and feet) in directions of the back and both sides of the LCD display during wireless modes of operation.

60-E-1

<Only for model with a “CE” mark on the bottom of the computer>

Declaration of Conformity (DoC)



“Hereby, Panasonic Corporation declares that this Personal Computer is in compliance with the essential requirements and other relevant provisions of the Directive 1999/5/EC.”

Hint:

If you want to get a copy of the original DoC of our above mentioned products, please contact our web address: <http://www.ptc.panasonic.eu>

Authorised Representative:

Panasonic Testing Centre
Panasonic Marketing Europe GmbH
Winsbergring 15, 22525 Hamburg, Germany

Network connection of Wired Modem.

The terminal equipment is intended for connection to the following public network;

In all the countries of European Economical Area and Turkey;

- Public Switched Telephony Networks

Technical Features of Wired Modem.

The terminal equipment includes the following features;

- DTMF dialing
- Maximum bitrate receiving mode: 56 kbit/s
- Maximum bitrate sending mode: 33.6 kbit/s

18-E-1

<Only for ATEX/IECEX compliant models>

Refer to the Addendum for ATEX/IECEX Information.

Regulatory Information

Models for UK

For your safety, please read the following text carefully.

This appliance is supplied with a molded three pin mains plug for your safety and convenience.

A 3 ampere fuse is fitted in this plug.

Should the fuse need to be replaced please ensure that the replacement fuse has a rating of 3 ampere and that it is approved by ASTA or BSI to BS1362.

Check for the ASTA mark  or the BSI mark  on the body of the fuse.

If the plug contains a removable fuse cover you must ensure that it is refitted when the fuse is replaced.

If you lose the fuse cover the plug must not be used until a replacement cover is obtained. A replacement fuse cover can be purchased from your local dealer.

If the fitted molded plug is unsuitable for the socket outlet in your home then the fuse should be removed and the plug cut off and disposed of safely.

There is a danger of severe electrical shock if the cut off plug is inserted into any 13-ampere socket.

How to replace the fuse

The location of the fuse differs according to the type of AC mains plug (figures A and B).

Confirm the AC mains plug fitted and follow the instructions below. Illustrations may differ from actual AC mains plug.

Open the fuse cover with a screwdriver and replace the fuse and close or attach the fuse cover.

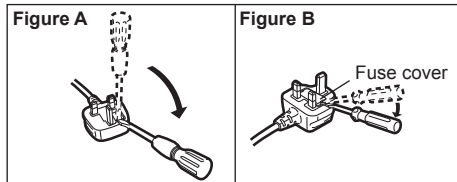

8-E-1

Models for India

[India Only]

Declaration of Conformity with the requirements of the e-waste (Management and Handling) Rules, 2011. (adopted by Notification S.O.1035(E) of Ministry of Environment and Forests)

The Product is in conformity with the requirements of Rule 13 of the e-waste Rules.

The content of hazardous substance with the exemption of the applications listed in SCHEDULE II of the e-waste Rules:

1. Lead (Pb) - not over 0.1% by weight;
2. Cadmium (Cd) - not over 0.01% by weight;
3. Mercury (Hg) - not over 0.1% by weight;
4. Hexavalent chromium (Cr6+) - not over 0.1% by weight;
5. Polybrominated biphenyls (PBBs) - not over 0.1% by weight;
6. Polybrominated diphenyl ethers (PBDEs) - not over 0.1% by weight.



For the purpose of recycling to facilitate effective utilization of resources, please return this product to a nearby authorized collection center, registered dismantler or recycler, or Panasonic service center when disposing of this product.

Please see the Panasonic website for further information on collection centers, etc.

<http://www.panasonic.com/in/corporate/sustainability/panasonic-india-i-recycle-program.html>

68-M-1

Models for Turkey

AEEE complies with Directive of Turkey.

66-M-1

AEEE Yönetmeliğine Uygundur.

66-Tr-1

First-time Operation

Read the downloaded "OPERATING INSTRUCTIONS - Basic Guide" (→ cover) as well which describe the basic operation when using this computer.

To display above, internet connection is needed. If you cannot display above, view the following.

(→  Connect to a network "LAN", "Disabling/Enabling Wireless Communication", "Wireless LAN", "Troubleshooting - Wireless Communication")

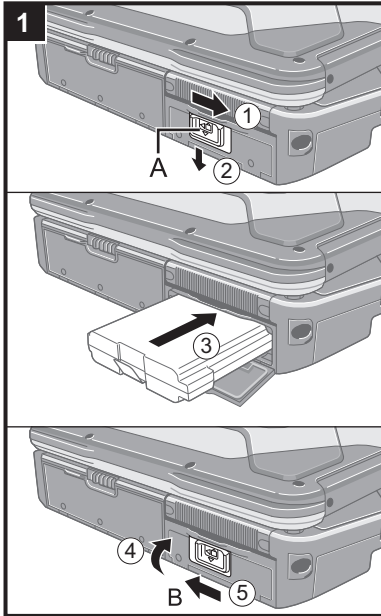

1 Inserting the Battery Pack

- ① Slide the latch (A) to the right to unlock the cover.
- ② Slide the latch (A) down, and open the cover.
- ③ Insert the battery pack until it securely fits the connector.
- ④ Close the cover until it clicks.
- ⑤ Slide the latch (B) to the left to lock the cover.

CAUTION

- Make sure the latch is securely locked. Otherwise the battery pack may fall when you carry the computer.
- Do not touch the terminals of the battery pack and the computer. Doing so can make the terminals dirty or damaged, and may cause malfunction of the battery pack and the computer.

NOTE

- Note that the computer consumes electricity even when the computer power is off. If the battery pack is fully charged, the battery will fully discharge in the following period of time:
 - When power is off: Approx. 10 weeks
 - In sleep: Approx. 4.5 days^{*1}
 - In hibernation: Approx. 10 days^{*1}

^{*1} If "Wake Up from wired LAN" is disabled, the period of time will be longer.
- When the DC plug is not connected to the computer, disconnect the AC cord from your electrical outlet. Power is consumed simply by having the AC adaptor plugged into an electrical outlet.

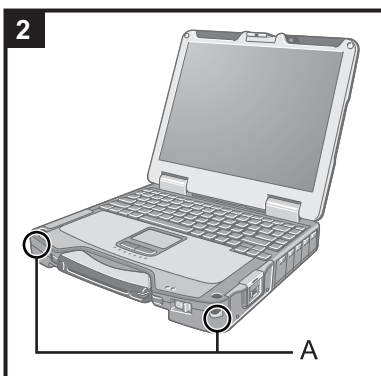

2 Attaching the stylus to the computer (only for model with touchscreen)

Use the tether to attach the stylus to the computer so you will not lose it. There are holes (A) to attach it.

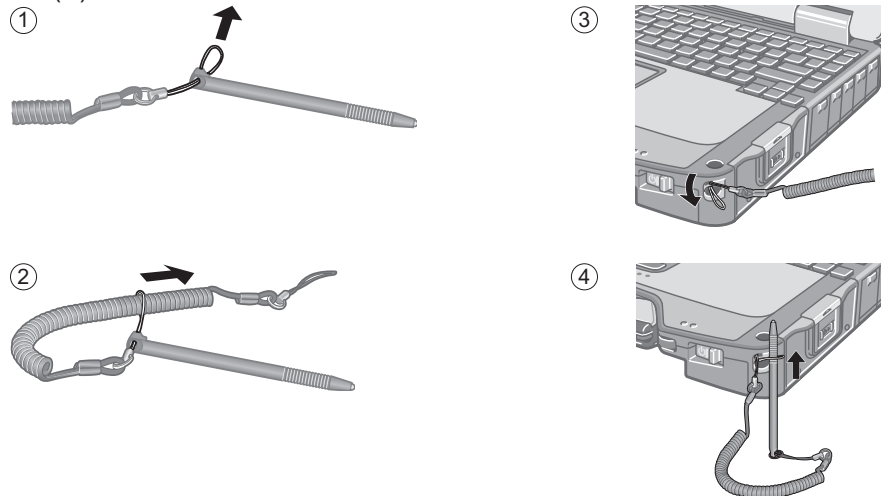

CAUTION

- Do not pull the tether with excessive force. The stylus may hit the computer, person's body or other objects when released.

First-time Operation

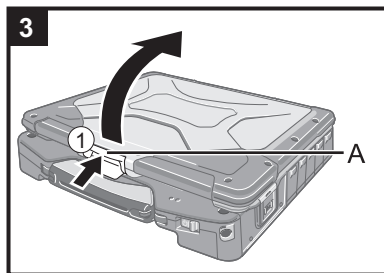

3 Opening the Display

- 1 Push and hold the latch (A), and lift open the display.

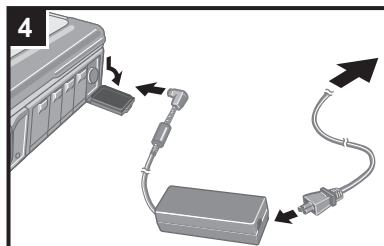

4 Connect your computer to a power outlet.

The battery charging starts automatically.

CAUTION

- Do not disconnect the AC adaptor and do not switch the wireless switch to on until the first-time operation procedure is completed.
- When using the computer for the first time, do not connect any peripheral device except the battery pack and AC adaptor.
- **Handling the AC adaptor**
 - Problems such as sudden voltage drops may arise during periods of thunder and lightning. Since this could adversely affect your computer, an uninterruptible power source (UPS) is highly recommended unless running from the battery pack alone.

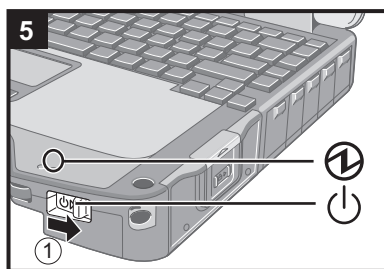

5 Turn on the computer.

- 1 Slide and hold the power switch  until the power indicator  lights.

CAUTION

- Do not slide the power switch repeatedly.
- The computer will forcibly be turned off if you slide and hold the power switch for 4 seconds or longer.
- Once you turn off the computer, wait for 10 seconds or more before you turn on the computer again.
- Do not perform the following operation until the drive indicator  turns off.
 - Connecting or disconnecting the AC adaptor
 - Sliding the power switch
 - Touching the keyboard, touch pad or touchscreen (only for model with touchscreen)
 - Closing the display
 - Turn on/off the wireless switch
- When the CPU temperature is high, the computer may not start up to prevent overheating of the CPU. Wait until the computer cools down, and then turn the power on again. If the computer does not power on even after cooling down, contact Panasonic Technical Support.
- Any changes from the default setting of the Setup Utility must not be made until the First-time Operation is completed.

6 **Windows 7**

<For MUI OS model>

Select language and OS (32-bit or 64-bit).

CAUTION

- Carefully choose your language because you cannot change it later. If you set a wrong language, you need to reinstall Windows.

- 1 Select language and OS (32bit or 64bit) on "Select OS" screen and click [OK]. The language setting will start by clicking [OK] on the confirmation screen. You can return to the "Select OS" screen by clicking [Cancel]. The language and OS setting will be completed in about 15 minutes.
- 2 When termination screen is displayed, click [OK] to turn off the computer.

7 Setup Windows.

Windows 8.1

Select language and click [Next].

Windows 7

Turn on the computer.

Follow the on-screen instructions.

- The computer restarts several times. Do not touch the keyboard or touch pad, and wait until the drive indicator  has turned off.
- After the computer is turned on, the screen remains black or unchanged for a while. This is not a malfunction. Wait for a moment until the Windows setup screen appears.
- During setup of Windows, use the touch pad and clicking to move the pointer and to click an item.
- Setup of Windows will take approximately **Windows 8.1** 5 minutes / **Windows 7** 20 minutes.
Go to the next step, confirming each message on the display.
- You can set the Wireless Network after the setup of Windows is complete.
 - Windows 8.1** If “Get online” is displayed, select “Skip this step”.
 - Windows 7** “Join a wireless network” screen may not appear.
- **Windows 8.1** Verify the time zone, date and time.

CAUTION

- You can change the user name, password, image and security setting after setup of Windows.
- Remember your password. If you forget the password, you cannot use Windows. Creating a password reset disk beforehand is recommended.
- Do not use the following words for user name: CON, PRN, AUX, CLOCK\$, NUL, COM1 to COM9, LPT1 to LPT9, @. In particular, if you create a user name (account name) that includes the “@” mark, a password will be requested at the log-on screen, even if no password has been set. If you try to log on without entering a password, “The user name or password is incorrect.” may be displayed and you will not be able to **Windows 8.1** sign in / **Windows 7** log on to Windows.
- Use standard characters as a computer name: numbers 0 through 9, uppercase and lowercase letters from A to Z, and the hyphen (-) character.
If the error message “The computer name is not valid” appears, check if characters other than the above are not entered. If the error message still remains on the display, set the key entry mode to English (“EN”) and enter characters.
<For MUI OS model>
- When setting up the keyboard, choose the appropriate one to your computer. Otherwise, input by the keyboard may become unavailable.

8 Update the on-screen manual.

- ① Connect a network to the internet.
For further information, refer to  *Connect to a network*.
- ② Update the on-screen manual.
Double-click [Manual Selector] on the desktop.
Follow the on-screen instructions.

9 Create the recovery disc.

A recovery disc allows you to install OS and restore its factory default condition, in case, for example, the recovery partition of the hard disk is damaged. We recommend creating a recovery disc before you begin using the computer.

Refer to →  *Reference Manual* “Recovery Disc Creation Utility” about creating the disc.



As an ENERGY STAR® Partner, Panasonic Corporation has determined that this product meets ENERGY STAR® guidelines for energy efficiency. By enabling available power management settings, Panasonic computers enter a low-power sleep mode after a period of inactivity, saving the user energy.

Outline of the International ENERGY STAR® Office Equipment Program

The international ENERGY STAR® Office Equipment Program is an international program that promotes energy saving through the use of computers and other office equipment. The program backs the development and dissemination of products with functions that effectively reduce energy consumption. It is an open system in which business proprietors can participate voluntarily. The targeted products are office equipment such as computers, displays, printers, facsimiles, and copiers. Their standards and logos are uniform among participating nations.

22-E-1

Panasonic Corporation
Osaka, Japan

Importer's name & address pursuant to the EU legislation.

Panasonic System Communications Company Europe, Panasonic Marketing Europe GmbH
Hagenauer Straße 43
65203 Wiesbaden
Germany