



Panasonic®

Personal Computer

Model No. **CF-31** series

Operating Instructions - Basic Guide

Getting Started

Introduction.....	2
Description of Parts.....	4
First-time Operation.....	7
Turning On / Turning Off.....	12

Getting Started

Useful Information

Handling and Maintenance.....	13
Installing Software.....	15

Useful Information

Troubleshooting

Troubleshooting (Basic).....	19
------------------------------	----

Troubleshooting

Appendix

LIMITED USE LICENSE AGREEMENT.....	24
Specifications.....	25
Standard Limited Warranty.....	28

Appendix

Please read these instructions carefully before using this product, and save this manual for future use.

Introduction









Thank you for purchasing this Panasonic product. For optimum performance and safety, please read these instructions carefully.

In these instructions, the names are referred as follows.

Windows 8.1 indicates Windows® 8.1 Operating System.

Windows 7 indicates Windows® 7 Operating System.

■ Terms and illustrations in these instructions

CAUTION :	Conditions that may result in minor or moderate injury.
NOTE :	Useful and helpful information.
Enter :	Press [Enter] key.
Fn + F5 :	Press and hold [Fn] key, and then press [F5] key.
Windows 8.1	
● Display “Charm”:	Align the pointer to the top right (or bottom right) corner of the screen to display Charm menu. Alternatively, flick toward the center of the screen from the right edge.
●  -  :	Click  (Settings) and then click  (Power).
Windows 7	
 (Start) - [All Programs] :	Click  (Start), and then click [All Programs]. You may need to double-click in some cases.
 :	Page in these Operating Instructions or in the Reference Manual.
 :	Reference to the on-screen manuals.

- Some illustrations are simplified to help your understanding and may look different from the actual unit.
- If you do not log on as an administrator, you cannot use some functions or cannot display some screens.
- Refer for the latest information about optional products to the catalogs, etc.
- In these instructions, the names and terms are referred as follows.
 - “Windows® 8.1 Pro 64-bit” as “Windows” or “Windows 8.1”
 - “Windows® 7 Professional 32-bit Service Pack 1” and “Windows® 7 Professional 64-bit Service Pack 1” as “Windows” or “Windows 7”
 - DVD MULTI drive as “CD/DVD drive”
 - Circular media including DVD-ROM and CD-ROM as “discs”
 - Multilanguage User Interface” as “MUJ”
- **Windows 8.1**
Screen messages are explained in [English (United States)].
(Depending on the language preference, some screen messages in these instructions are different from the actual screen messages. For example, [Flight mode] may be displayed instead of [Airplane mode] in some language preference.)

■ Disclaimer

Computer specifications and manuals are subject to change without notice. Panasonic Corporation assumes no liability for damage incurred directly or indirectly from errors, omissions or discrepancies between the computer and the manuals.

■ Trademarks

Microsoft®, Windows®, the Windows logo, and IntelliMouse are registered trademarks of Microsoft Corporation of the United States and/or other countries.

Intel, Core and PROSet are either registered trademarks or trademarks of Intel Corporation.

SDXC Logo is a trademark of SD-3C, LLC.



Adobe, the Adobe logo and Adobe Reader are either registered trademarks or trademarks of Adobe Systems Incorporated in the United States and/or other countries.

Bluetooth® is a registered trademark owned by Bluetooth SIG, Inc., U.S.A. and licensed to Panasonic Corporation.

HDMI, the HDMI Logo and High-Definition Multimedia Interface are trademarks or registered trademarks of HDMI Licensing LLC in the United States and other countries.

Names of products, brands, etc., appearing in this manual are trademarks or registered trademarks of their respective own companies.

■ On-screen Manual

For further information about the computer, you can refer to the on-screen manual.

● Reference Manual

The Reference Manual contains the practical information to help you fully enjoy the computer's performance. Update it to the latest version for reference.

● Important Battery Tips

The Important Battery Tips will provide you with the battery information so that you can use the battery in the optimum condition to obtain longer operation time.

● Update the on-screen manuals

This describes the procedures to update the on-screen manual.

● Connect to a network

This describes the connection procedures using the network devices mounted on this unit.

To access the on-screen manuals, follow the steps below.

Double-click [Manual Selector] on the desktop, and select the on-screen manual.

NOTE

- [Contents] tab or [Search] tab is displayed on the left side of the window. Select tab and display the desired item.

Description of Parts

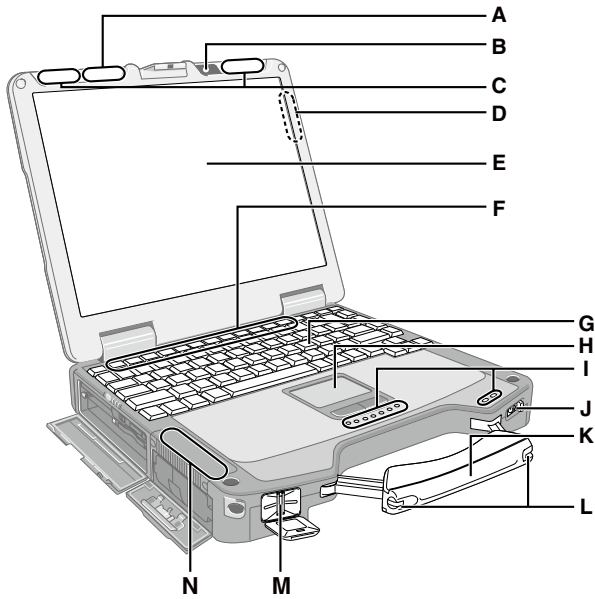

Left side

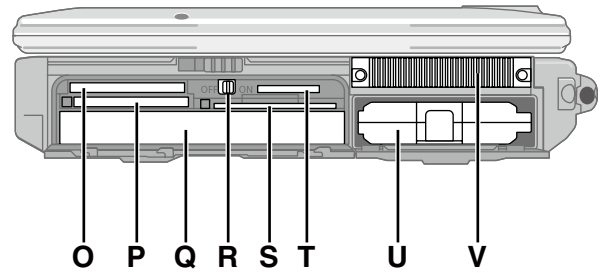

A: Wireless LAN Antenna

<Only for model with wireless LAN>

→ *Connect to a network* "Wireless LAN"

<Only for model with Bluetooth>

→ *Connect to a network* "Bluetooth"

B: Camera

<Only for model with Camera>

C: Wireless WAN Antenna

<Only for model with wireless WAN>

→ *Connect to a network* "Wireless WAN"

D: GPS Antenna (Rear side)

<Only for model with GPS>

E: LCD

→ *Reference Manual* "Screen Input Operation"
(Only for model with touchscreen)

F: Function Key

→ *Reference Manual* "Key Combinations"

G: Keyboard

H: Touch Pad

I: LED Indicator

: SD Memory Card Indicator
(Blinking: During access)

→ *Reference Manual* "SD Memory Card"

: Wireless ready

This indicator lights when Wireless LAN, Bluetooth, and/or Wireless WAN are connected and ready. It does not necessarily indicate the On/Off condition of the wireless connection.

→ *Connect to a network*

: Caps Lock

: Numeric Lock (NumLk)

: Scroll Lock (ScrLk)

: Drive indicator

: Multimedia pocket device status or the second battery status.

: Battery status

→ *Reference Manual* "Battery Power"

: Power status

(Off: Power off/Hibernation, Green: Power on, Blinking green: Sleep)

J: Power Switch

K: Carrying Handle

L: Stylus Holder

M: Fingerprint Reader

<Only for model with Fingerprint Reader>

→ *Reference Manual* "Fingerprint Reader"

N: Wireless LAN Antenna / Bluetooth Antenna

<Only for model with wireless LAN>

→ *Connect to a network* "Wireless LAN"

<Only for model with Bluetooth>

→ *Connect to a network* "Bluetooth"

O: ExpressCard Slot

→ *Reference Manual* "PC Card / ExpressCard"

P: PC Card Slot

→ *Reference Manual* "PC Card / ExpressCard"

Q: Multimedia Pocket

→ *Reference Manual* "Multimedia Pocket"

R: Wireless Switch

→ *Connect to a network* "Disabling/Enabling Wireless Communication"

S: Smart Card Slot

→ *Reference Manual* "Smart Card"

T: SD Memory Card Slot

Keep SD Memory Cards Away from Infants and Small Children.

→ *Reference Manual* "SD Memory Card"

U: Battery Pack

Specified Battery pack: CF-VZSU46AU

V: Ventilation Hole (Exhaust)

Right side

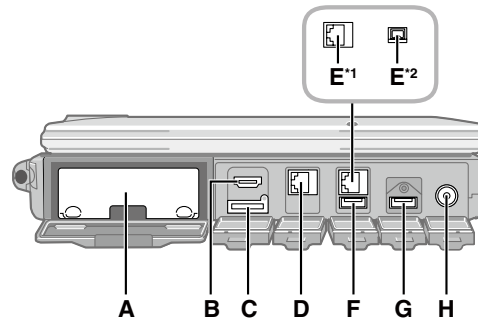

Rear side

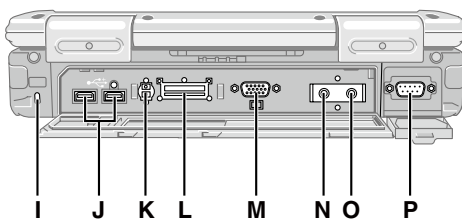

Bottom

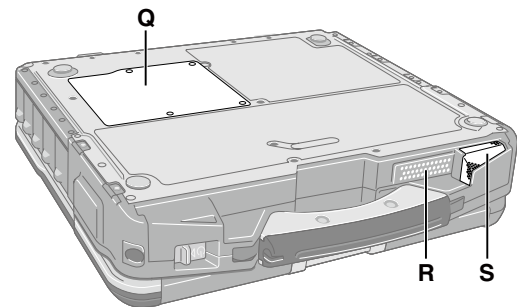

A: Hard Disk Drive

→ Reference Manual "Hard Disk Drive"

B: HDMI Port

→ Reference Manual "External Display"

C: SIM Card Slot

<Only for model with wireless WAN>

Insert the SIM card into the SIM card slot with the contact side facing down and the cut corner facing forward.

→ Connect to a network "Wireless WAN"

D: LAN Port

→ Connect to a network "LAN"

E: 2nd LAN Port^{*1} / IEEE 1394 Interface Connector^{*2}

^{*1} <Only for model with 2nd LAN>

→ Connect to a network "LAN"

^{*2} <Only for model with IEEE 1394>

→ Reference Manual "IEEE 1394 Devices"

F: USB Port (2.0)

→ Reference Manual "USB Devices"

G: USB Port (3.0)

→ Reference Manual "USB Devices"

H: DC-IN Jack

I: Security Lock

A Kensington cable can be connected.

For further information, read the manual that comes with the cable.

J: USB Port (2.0)

→ Reference Manual "USB Devices"

K: External Antenna Connector

L: Expansion Bus Connector

→ Reference Manual "Port Replicator / Car Mounter"

M: External Display Port (VGA)

→ Reference Manual "External Display"

N: Headphone Jack

You can connect headphones or amplified speakers. When they are connected, audio from the internal speakers is not heard.

O: Microphone Jack

A condenser microphone can be used. If other types of microphones are used, audio input may not be possible, or malfunctions may occur as a result.

P: Serial Port

Q: RAM Module Slot

→ Reference Manual "RAM Module"

R: Speaker

<Only for model with Camera>

Do not turn the speaker volume and/or microphone volume up too loud. Feedback noise may occur.

→ Reference Manual "Key Combinations"

S: Ventilation Hole (Intake)

Description of Parts

- This computer contains a magnet and magnetic products at the locations circled in the illustration at right. Avoid leaving metallic object or magnetic media in contact with these areas.



First-time Operation

■ Preparation

① Check and identify the supplied accessories.

If you do not find the described accessories, contact Panasonic Technical Support.

- AC Adaptor 1
- AC Cord 1
- Battery Pack 1



Model No: CF-AA5713A

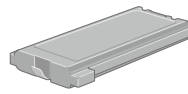
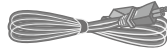

Model No: CF-VZSU46AU
(Refer to “Specifications” (→ page 25).)

<Only for model with touchscreen>

- Soft Cloth 1
- Tether 1
- Stylus 1

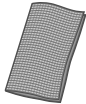

(→ Reference Manual “Screen Input Operation”)

- OPERATING INSTRUCTIONS - Read Me First 1

② Read the LIMITED USE LICENSE AGREEMENT before breaking the seal on the computer’s packaging (→ page 24).

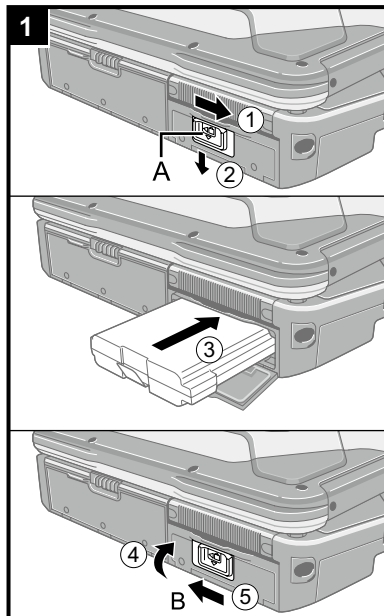

1 Inserting the Battery Pack

- ① Slide the latch (A) to the right to unlock the cover.
- ② Slide the latch (A) down, and open the cover.
- ③ Insert the battery pack until it securely fits the connector.
- ④ Close the cover until it clicks.
- ⑤ Slide the latch (B) to the left to lock the cover.

CAUTION

- Make sure the latch is securely locked. Otherwise the battery pack may fall when you carry the computer.
- Do not touch the terminals of the battery pack and the computer. Doing so can make the terminals dirty or damaged, and may cause malfunction of the battery pack and the computer.

NOTE

- Note that the computer consumes electricity even when the computer power is off. If the battery pack is fully charged, the battery will fully discharge in the following period of time:
 - When power is off: Approx. 10 weeks
 - In sleep: Approx. 4.5 days^{**1}
 - In hibernation: Approx. 10 days^{**1}

^{**1} If “Wake Up from wired LAN” is disabled, the period of time will be longer.
- When the DC plug is not connected to the computer, disconnect the AC cord from your electrical outlet. Power is consumed simply by having the AC adaptor plugged into an electrical outlet.

First-time Operation

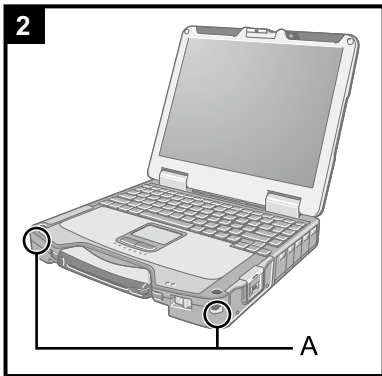

2 Attaching the stylus to the computer (only for model with touchscreen)

Use the tether to attach the stylus to the computer so you will not lose it. There are holes (A) to attach it.

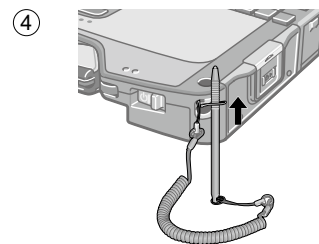
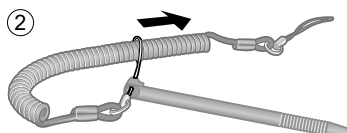
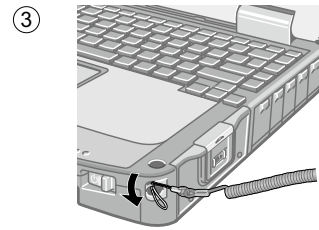

CAUTION

- Do not pull the tether with excessive force. The stylus may hit the computer, person's body or other objects when released.

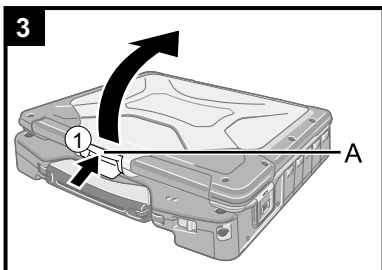

3 Opening the Display

- Push and hold the latch (A), and lift open the display.

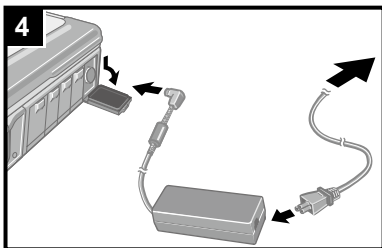

4 Connect your computer to a power outlet.



The battery charging starts automatically.

CAUTION

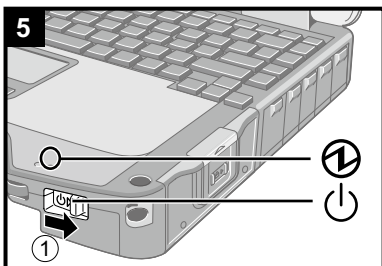
- Do not disconnect the AC adaptor and do not switch the wireless switch to on until the first-time operation procedure is completed.
- When using the computer for the first time, do not connect any peripheral device except the battery pack and AC adaptor.
- Handling the AC adaptor**
 - Problems such as sudden voltage drops may arise during periods of thunder and lightning. Since this could adversely affect your computer, an uninterruptible power source (UPS) is highly recommended unless running from the battery pack alone.



5 Turn on the computer.

- Slide and hold the power switch  until the power indicator  lights.

CAUTION

- Do not slide the power switch repeatedly.
- The computer will forcibly be turned off if you slide and hold the power switch for 4 seconds or longer.
- Once you turn off the computer, wait for 10 seconds or more before you turn on the computer again.
- Do not perform the following operation until the drive indicator  turns off.
 - Connecting or disconnecting the AC adaptor
 - Sliding the power switch

- Touching the keyboard, touch pad or touchscreen (only for model with touchscreen)
- Closing the display
- Turn on/off the wireless switch
- When the CPU temperature is high, the computer may not start up to prevent overheating of the CPU. Wait until the computer cools down, and then turn the power on again. If the computer does not power on even after cooling down, contact Panasonic Technical Support.
- Any changes from the default setting of the Setup Utility must not be made until the First-time Operation is completed.

6 **Windows 7** <For MUI OS model> Select language and OS (32-bit or 64-bit).

CAUTION

- Carefully choose your language because you cannot change it later. If you set a wrong language, you need to reinstall Windows.
 - ① Select language and OS (32bit or 64bit) and click [OK].
The language setting will start by clicking [OK] on the confirmation screen. You can return to the "Select OS" screen by clicking [Cancel].
The language and OS setting will be completed in about 15 minutes.
 - ② When termination screen is displayed, click [OK] to turn off the computer.

7 Setup Windows.

Windows 8.1

Select language and click [Next].

Windows 7

Turn on the computer.

Follow the on-screen instructions.

- The computer restarts several times. Do not touch the keyboard or touch pad, and wait until the drive indicator  has turned off.
- After the computer is turned on, the screen remains black or unchanged for a while. This is not a malfunction. Wait for a moment until the Windows setup screen appears.
- During setup of Windows, use the touch pad and clicking to move the pointer and to click an item.
- Setup of Windows will take approximately **Windows 8.1** 5 minutes / **Windows 7** 20 minutes.
Go to the next step, confirming each message on the display.
- You can set the Wireless Network after the setup of Windows is complete.
 - Windows 8.1** If "Get online" is displayed, select "Skip this step".
 - Windows 7** "Join a wireless network" screen may not appear.
- **Windows 8.1** Verify the time zone, date and time.

CAUTION

- You can change the user name, password, image and security setting after setup of Windows.
- Remember your password. If you forget the password, you cannot use Windows. Creating a password reset disk beforehand is recommended.
- Do not use the following words for user name: CON, PRN, AUX, CLOCK\$, NUL, COM1 to COM9, LPT1 to LPT9, @. In particular, if you create a user name (account name) that includes the “@” mark, a password will be requested at the log-on screen, even if no password has been set. If you try to log on without entering a password, “The user name or password is incorrect.” may be displayed and you will not be able to **Windows 8.1** sign in / **Windows 7** log on to Windows (→ page 21).
- Use standard characters as a computer name: numbers 0 through 9, uppercase and lowercase letters from A to Z, and the hyphen (-) character. If the error message “The computer name is not valid” appears, check if characters other than the above are not entered. If the error message still remains on the display, set the key entry mode to English (“EN”) and enter characters.
<For MUI OS model>
- When setting up the keyboard, choose the appropriate one to your computer. Otherwise, input by the keyboard may become unavailable.

8 Update the on-screen manual.

- ① Connect a network to the internet.
For further information, refer to  *Connect to a network*.
- ② Update the on-screen manual.
Double-click [Manual Selector] on the desktop.
Follow the on-screen instructions.

9 Create the recovery disc.

A recovery disc allows you to install OS and restore its factory default condition, in case, for example, the recovery partition of the hard disk is damaged. We recommend creating a recovery disc before you begin using the computer.

Refer to →  *Reference Manual* “Recovery Disc Creation Utility” about creating the disc.

NOTE

● PC Information Viewer

This computer periodically records the management information of the hard disk, etc. The maximum data volume for each record is 1024 bytes.

This information is only used for estimating the cause in the case when the hard disk goes down by any possibility. They are never sent to outside via network nor used for any other purpose except for the purpose described the above.

To disable the function, add the check mark for [Disable the automatic save function for management information history] in [Hard Disk Status] of PC Information Viewer, and click [OK].

(→  *Reference Manual* “Checking the Computer’s Usage Status”)

<For MUI OS model>

- **Windows 8.1**
In the default settings, a shortcut icon for Korean language is on the Desktop screen. You may delete the icon if not necessary.
- **Windows 7** If the recovery partition is deleted, you cannot create Recovery Disc(s).

■ Before using wireless function



- ① Slide the wireless switch to ON.

Windows 8.1

- ② Display “Charm” and click  - [Change PC Settings] - [Network] - [Airplane mode].
Set [Wi-Fi] to [On] (for wireless LAN).
set [Mobile broadband] to [On] (for wireless WAN).
set [GPS] to [On] (for wireless WAN).
set [Bluetooth] to [On] (for Bluetooth).

■ To change the partition structure

You can shrink a part of an existing partition to create unallocated disk space, from which you can create a new partition.



- ① **Windows 8.1**
Right-click  at the bottom left corner of the Desktop screen.
 - Windows 7**
Click  (Start) and right-click [Computer], then click [Manage].
 - A standard user needs to enter an administrator password.
 - ② Click [Disk Management].
 - ③ Right-click the partition for Windows ("c" drive in the default setting), and click [Shrink Volume].
 - The partition size depends on the computer specifications.
 - ④ Input the size in [Enter the amount of space to shrink in MB] and click [Shrink].
 - You cannot input a larger number than the displayed size.
 - To select [Reinstall to the OS related partitions.] in reinstalling the software (→ page 16), the following size is necessary for [Total size after shrink in MB].
 - Windows 8.1** 70000 MB² or more
 - Windows 7** 60000 MB or more
 - ⑤ Right-click [Unallocated] (the shrunk space in the step ④) and click [New Simple Volume].
 - ⑥ Follow the on-screen instructions to make the settings, and click [Finish].
Wait until formatting is completed.
- ² For MUI OS model, 80 GB or more is necessary.

NOTE

- You can create an additional partition using remaining unallocated space or newly creating unallocated space.
- To delete a partition, right-click the partition and click [Delete Volume] in the step ③.

■ **Windows 8.1** <For MUI OS model> To select language

To select a language other than the one you have selected during the first-time operation, follow the steps below.



- ① Perform either of the following procedures.
 - Right-click  at the bottom left corner of the Desktop screen.
 - Click  on the Start screen.
- ② Click [Control Panel].
- ③ Click [Clock, Language, and Region] - [Language] - [Add a language].
- ④ Select a language, and then click [Add].
Depending on the region, two or more languages are selectable. Click [Open] and select the desired language, and then click [Add].
- ⑤ Click [Option] for the language you want to use.
- ⑥ Click [Make this the primary language].

NOTE

- If [Make this the primary language] is not displayed, you cannot change to this language. Follow the on-screen instructions.
- ⑦ Click [Log off now].
 - ⑧ Sign in to the Windows.

Turning On / Turning Off

Turning On

Slide and hold the power switch  (→ page 4) until the power indicator  (→ page 4) lights.



NOTE

- Do not slide the power switch repeatedly.
- The computer will forcibly be turned off if you slide and hold the power switch for four seconds or longer.
- Once you turn off the computer, wait for ten seconds or more before you turn on the computer again.
- Do not perform the following operation until the drive indicator  turns off.
 - Connecting or disconnecting the AC adaptor
 - Sliding the power switch
 - Touching the keyboard, touch pad, screen or external mouse
 - Closing the display
 - Turn on/off the wireless switch

Turning Off

Windows 8.1

You can shut down the computer by using either of the following steps.

- From the Start screen:
 - ① Click  - [Shut down].
- From the Desktop screen:
 - ① Right-click  at the bottom left corner of the Desktop screen.
 - ② Click [Shut down or sign out] - [Shut down].

Windows 7

- ① Click  (Start) - [Shutdown].

NOTE

- **Windows 8.1**

To turn off the computer completely, proceed as follows.

 - ① Display “Charm” and click  - [Change PC settings] - [Update and recovery] - [Recovery].
 - ② Click [Restart now] under “Advanced startup”
 - ③ Click [Turn off your PC].

Precautions against Starting Up/Shutting Down

- Do not do the following
 - Connecting or disconnecting the AC adaptor
 - Sliding the power switch
 - Touching the keyboard, touch pad, screen or external mouse
 - Closing the display
 - Turn on/off the wireless switch

NOTE

- To conserve power, the following power saving methods are set at the time of purchase.
 - The screen automatically turns off after :
 - 10 minutes (when AC adaptor is connected) of inactivity
 - 5 minutes (when operating on battery power) of inactivity
 - The computer automatically enters sleep^{*1} after :
 - 30 minutes (when AC adaptor is connected) of inactivity
 - 15 minutes (when operating on battery power) of inactivity

^{*1} Refer to  *Reference Manual* “Sleep or Hibernation Functions” about resuming from sleep.

Handling and Maintenance

Operation environment

- Place the computer on a flat stable surface not subject to shock, vibration, and danger of dropping. Do not place the computer upright or turn it over. If the computer is exposed to an extremely strong impact, it may become damaged.
- Operating environment
 - Temperature: Operation : -10 °C to 50 °C (IEC60068-2-1, 2)^{*1}
 - Storage : -20 °C to 60 °C
 - Humidity: Operation : 30% to 80% RH (No condensation)
 - Storage : 30% to 90% RH (No condensation)

Even within the above temperature/humidity ranges, operation for a long time in extreme environments, smoking nearby, or operation in places where oil is used or where there is a lot of dust will result in the product deterioration and will shorten the product life.
- ^{*1} Do not expose the skin to this product when using the product in a hot or cold environment. (→ OPERATING INSTRUCTIONS - Read Me First)
If the computer is wet in temperatures of 0 °C or below, freeze damage may occur. Make sure to dry off the computer in such temperatures.
- Do not place the computer in the following areas, otherwise the computer may be damaged.
 - Near electronic equipment. Image distortion or noise may occur.
 - In extremely high or low temperature.
- As the computer can become hot during operation, keep it away from items that are sensitive to heat.

Handling cautions

This computer is designed to minimize shock to parts such as the LCD and the hard disk drive and equipped with a drip-proof keyboard, but no warranty is provided against any trouble caused by shock. Be extremely careful when handling the computer.

- When carrying the computer:
 - Turn off the computer.
 - Remove all external devices, cables, PC Cards and other protruding objects.
 - Remove a disc in the CD/DVD drive.
 - Do not drop or hit the computer against solid objects.
 - Do not leave the display open.
 - Do not grip the display part.
 - Do not put anything (e.g., a piece of paper) between the display and keyboard.
 - When you board an airplane, take the computer with you and never put it in your checked luggage. When using the computer on airplane, follow the airline's instructions.
 - When carrying a spare battery, put it in a plastic bag to protect its terminals.
 - The touch pad is designed to be used by finger tip. Do not place any object on its surface and do not press down strongly with sharp-pointed or hard objects that may leave marks (e.g., nails, pencils and ball point pens).
 - Avoid any harmful substances such as oil from getting into the touch pad. The pointer may not work correctly.
 - Be careful not to get injured by dropping or getting hit when carrying the computer.
- <Only for model with touchscreen>
- Use only the included stylus to touch the touchscreen. Do not place any object on its surface and do not press down strongly with sharp-pointed or hard objects that may leave marks (e.g., nails, pencils and ball point pens).
 - Do not use the touchscreen when dust or dirt (e.g., oil) is on the screen. Otherwise foreign particles on the screen/stylus can scratch the screen surface or obstruct the stylus operation.
 - Use the stylus only for touching the screen. Using it for any other purpose may damage the stylus and result in scratches on the screen.

■ When using peripheral devices

Follow these instructions and the Reference Manual to avoid any damage to the devices. Carefully read the instruction manuals of the peripheral devices.

- Use the peripheral devices conforming to the computer's specifications.
- Connect to the connectors in the correct direction.
- If it is hard to insert, do not try forcibly but check the connector's shape, direction, alignment of pins, etc.
- If screws are included, fasten them securely.
- Remove the cables when you carry the computer. Do not pull the cables forcibly.

Handling and Maintenance

■ Preventing your computer from unauthorized use via wireless LAN/Bluetooth/wireless WAN

<Only for model with wireless LAN/Bluetooth/wireless WAN>

- Before using wireless LAN/Bluetooth/wireless WAN, make the appropriate security settings such as data encryption.

■ Battery Recalibration

- The battery recalibration may take a long time due to the large battery capacity. This is not a malfunction.

<When performing "Battery Recalibration" after shutting down Windows>

- Full charge: Approximately 3.5 hours (with Main Battery) / 7.0 hours (with Main Battery + Second Battery)
- Complete discharge: Approximately 5.0 hours (with Main Battery) / 7.5 hours (with Main Battery + Second Battery)

When performing "Battery Recalibration" without shutting down Windows, it may take more time to charge / discharge.

Maintenance

To clean the LCD panel

If drops of water or other stains get on the surface of the LCD panel, wipe them off immediately. Failure to do so may result in staining.

<Only for model with touchscreen>

Use the soft cloth included with the computer. (For further information, refer to "Suggestions About Cleaning the LCD Surface". →  *Reference Manual* "Screen Input Operation")

To clean areas other than the LCD panel

Wipe with a soft dry cloth such as gauze. When using detergent, dip a soft cloth in water-diluted detergent and wring it thoroughly.

CAUTION



- Do not use benzene, thinner, or rubbing alcohol since it may adversely affect the surface causing discoloration, etc. Do not use commercially-available household cleaners and cosmetics, as they may contain components harmful to the surface.
- Do not apply water or detergent directly to the computer, since liquid may enter inside of the computer and cause malfunction or damage.

Installing Software

Installing software will return the computer to the default condition. When you install the software, the hard disk data will be erased.

Back up important data to other media or an external hard disk before installation.

CAUTION

- Do not delete the Recovery Partition on the hard disk. The disk space in the partition is not available to store data. To check the Recovery Partition, perform the following methods.
 - ① **Windows 8.1**
Right-click  at the bottom left corner of the Desktop screen.
Windows 7
Click  (Start) and right-click [Computer], then click [Manage].
 - A standard user needs to enter an administrator password.
 - ② Click [Disk Management].

■ **Windows 8.1** Remove everything and reinstall Windows

Preparation

- Remove all peripherals.
- Connect the AC adaptor and do not remove it until installation is complete.

1 Perform “Remove everything and reinstall Windows”.

- ① Display “Charm” and click  - [Change PC settings] - [Update and recovery] - [Recovery].
- ② Click [Get Started] under “Remove everything and reinstall Windows”.
- ③ Click [Next].
- ④ Select the option.
 - Just remove my files
Perform the reinstallation of the Windows in a few moments (Approximately 20 minutes).
 - Fully clean the drive
By fully cleaning, the deleted files can not be recovered easily and the security level will be increased.
The processing time will be longer (Approximately 140 minutes).Follow the on-screen instructions.
After the reinstallation, the computer will restart.
- Do not interrupt installation, for example by turning off the computer or performing other operation.
Otherwise installation may become unavailable as Windows may not start up or the data may be corrupted.



2 Perform the “First-time Operation” (→ page 9).

NOTE

- The date and time, and the time zone may not be correct. Be sure to set them correctly.

3 Perform Windows Update.

4 <Only for model with TPM> Clear TPM.

- ① Perform either of the following procedures.
 - Right-click  at the bottom left corner of the Desktop screen.
 - Click  on the Start screen.
- ② Click [Run], then input [tpm.msc] and click [OK].
- ③ Click [Clear TPM...] under “Actions” on the right of the “TPM Manager on Local Computer” screen.
- ④ Click [Restart] of the “Manage the TPM security hardware” screen.
The computer will restart.
- ⑤ When “TPM configuration change was requested to ...” is displayed, press **F12**.
- ⑥ When “TPM is ready” appears, click [Close].

Installing Software

■ Hard disk recovery

You can reinstall the OS that was pre-installed at the time of purchase (Windows 8.1 or Windows 7).

Windows 8.1 If reinstallation using the method described in “Remove everything and reinstall Windows” is not successful, follow the steps below.

Preparation

- Remove all peripherals.
- Connect the AC adaptor and do not remove it until installation is complete.

1 Start the Setup Utility.

Windows 8.1

- ① Display “Charm”, and click  - [Change PC settings] - [Update and recovery] - [Recovery].
- ② Click [Restart now] under “Advanced startup”.
- ③ Click [Troubleshoot] - [Advanced options] - [UEFI Firmware Settings] - [Restart].

Windows 7

Turn on the computer, and press **F2** or **Del** while [Panasonic] boot screen is displayed.

- If the [Panasonic] boot screen is not displayed, turn on the computer while holding down **F2** or **Del**.
- If the password is requested, enter the Supervisor Password.

2 Write down all of the contents of the Setup Utility and press **F9**.

At the confirmation message, select [Yes] and press **Enter**.

3 Check the [UEFI Boot] setting of the Setup Utility.

[UEFI Boot] should be set to as follows.

When installing Windows 8.1 : [Enabled]

When installing Windows 7 : [Disabled]

4 Press **F10**.

At the confirmation message, select [Yes] and press **Enter**.

Computer will restart.

5 Press **F2** or **Del** while [Panasonic] boot screen is displayed.

The Setup Utility starts up.

- If the password is requested, enter the Supervisor Password.

6 Select the [Exit] menu, then select [Recovery Partition] and press **Enter**.

Windows 8.1

Click [Next] and click [YES].

Windows 7

Click [Reinstall Windows] and click [Next].

8 At the License Agreement screen, click [Yes, I agree to the provisions above and wish to continue!] and click [Next].

9 Click [Next].

If the option is displayed, select the setting and click [Next].

- [Reinstall Windows to the whole Disk to factory default.]
Select this option when you want to install Windows to the factory default. After installation, you can create a new partition. For how to create a new partition, refer to “To change the partition structure” (→ page 11).
- [Reinstall to the OS related partitions.]¹
Select this option when the hard disk has already been divided into several partitions and you want to keep the partition structure. For how to create a new partition, refer to “To change the partition structure” (→ page 11).

¹ This does not appear if Windows cannot be installed to the recovery partition and the area usable by Windows.

10 **Windows 7** At the confirmation message, click [YES].

Windows 7

<For localized OS model>

Select OS (32bit or 64bit) and click [OK].

<For MUI OS model>

Select language and system type (32bit or 64bit) and click [OK].

At the confirmation message, click [OK].

To cancel the recovery procedure, click [CANCEL], and click  the mark that appears at the top right corner of the screen.

12 At the confirmation message, click [YES].

Installation starts according to the instructions on the screen. (It will take approximately 20 minutes.)

- Do not interrupt installation, for example by turning off the computer or performing other operation. Otherwise installation may become unavailable as Windows may not start up or the data may be corrupted.

13 When Ending process screen is displayed, click [OK] to turn off the computer.**14 Turn on the computer.**

- If the password is requested, enter the Supervisor Password.

15 Perform the “First-time Operation” (→ page 9).**NOTE**

- **Windows 8.1** The date and time, and the time zone may not be correct. Be sure to set them correctly.

16 Start the Setup Utility and change the settings as necessary.**17 Perform Windows Update.****18 **Windows 8.1** <Only for model with TPM> Clear TPM (→ page 15).****■ Using Recovery Disc**

Use the Recovery Disc in the following conditions.

- You have forgotten the administrator password.
- Installation is not complete. The recovery partition in the hard disk may be broken.
- **Windows 7** <Only for Windows 7 downgrade model>
To change OS from Windows 7 to Windows 8.1, or vice versa.

NOTE

- **Windows 7** To change OS from 32 bit to 64 bit, or vice versa, install OS using the recovery partition in the hard disk.

Preparation

- Prepare the following items:
 - Recovery Disc (→  *Reference Manual* “Recovery Disc Creation Utility”)
 - DVD drive (optional) (refer to recent catalogs and other sources for information about the products available)
- Remove all peripherals.
- Connect the AC adaptor and do not remove it until installation is complete.

1 Connect the DVD drive to the USB port or Multimedia Pocket.**2 Start the Setup Utility.****Windows 8.1**

- ① Display “Charm”, and click  - [Change PC settings] - [Update and recovery] - [Recovery].
- ② Click [Restart now] under “Advanced startup”.
- ③ Click [Troubleshoot] - [Advanced options] - [UEFI Firmware Settings] - [Restart].

Windows 7

Turn on the computer, and press **F2** or **Del** while [Panasonic] boot screen is displayed.

- If the [Panasonic] boot screen is not displayed, turn on the computer while holding down **F2** or **Del**.
- If the password is requested, enter the Supervisor Password.

3 Write down all of the contents of the Setup Utility and press **F9.**

At the confirmation message, select [Yes] and press **Enter**.

4 Check the [UEFI Boot] setting of the Setup Utility.

[UEFI Boot] should be set to as follows.

When the recovery disc for Windows 8.1 is used : [Enabled]

When the recovery disc for Windows 7 is used : [Disabled]

5 Set the Recovery Disc into the DVD drive.**6 Press **F10**.**

At the confirmation message, select [Yes] and press **Enter**.

Computer will restart.

7 Press **F2 or **Del** while [Panasonic] boot screen is displayed.**

The Setup Utility starts up.

- If the password is requested, enter the Supervisor Password.

Installing Software

8 Select the [Exit] menu, then select your DVD drive in [Boot Override] and press **Enter**.
The computer will restart.

9 Click [Reinstall Windows] and click [Next].

10 **Windows 8.1** At the confirmation message, click [YES].

11 At the License Agreement screen, click [Yes, I agree to the provisions above and wish to continue!] and click [Next].

12 **Windows 7** <For MUI OS model>
Click [Next].

If the option is displayed, select the setting and click [Next].

- [Reinstall with HDD recovery partition.]
Standard recovery method.
You can use recovery from Recovery Partition.
- [Reinstall without HDD recovery partition.]
Increase usable HDD size.
You can NOT use recovery from Recovery Partition.
When this option is selected, you can no longer create Recovery Disc(s) after the recovery operation.

CAUTION

- Carefully choose above item because you cannot change it later.

13 Click [Next].

If the option is displayed, select the setting and click [Next].

- [Reinstall Windows to the whole Disk to factory default.]
Select this option when you want to install Windows to the factory default. After installation, you can create a new partition. For how to create a new partition, refer to "To change the partition structure" (→ page 11).
- [Reinstall to the OS related partitions.]²
Select this option when the hard disk has already been divided into several partitions and you want to keep the partition structure. For how to create a new partition, refer to "To change the partition structure" (→ page 11).
² This does not appear if Windows cannot be installed to the recovery partition and the area usable by Windows.

14 At the confirmation message, click [YES].

15 **Windows 7** <For MUI OS model>

Select language and system type (32bit or 64bit) and click [OK].

At the confirmation message, click [OK].

To cancel the recovery procedure, click [CANCEL], and click the  mark that appears at the top right corner of the screen.

Windows 7 / **Windows 8.1**

Installation starts according to the instructions on the screen. (It will take approximately 30 - 45 minutes.)

- Do not interrupt installation, for example by turning off the computer or pressing **Ctrl + Alt + Del**.
Otherwise installation may become unavailable as Windows may not start up or the data may be corrupted.

16 When Ending process screen is displayed, remove the Recovery Disc and DVD Drive and then click [OK].

Windows 8.1 Turn on the wireless switch.

Follow the on-screen instructions.

Some models may take approximately 40 minutes.

17 **Windows 8.1** When Ending process screen is displayed, click [OK] and then turn off the wireless switch.

18 Perform the "First-time Operation" (→ page 9).

19 Start the Setup Utility and change the settings as necessary.

20 Perform Windows Update.

21 **Windows 8.1** <Only for model with TPM> Clear TPM (→ page 15).

Troubleshooting (Basic)







Follow the instructions below when a problem has occurred. There is also an advanced troubleshooting guide in the "Reference Manual". For a software problem, refer to the software's instruction manual. If the problem persists, contact Panasonic Technical Support. You can also check the computer's status in the PC Information Viewer (→  Reference Manual "Troubleshooting (Advanced)").

■ Starting Up





<p>Cannot start up. The power indicator or battery indicator is not lit.</p>	<ul style="list-style-type: none"> ● Connect the AC adaptor. ● Insert a fully charged battery. ● Remove the battery pack and the AC adaptor, then connect them again. ● If a device is connected to the USB port, disconnect the device, or set [USB Port] or [Legacy USB Support] to [Disabled] in the [Advanced] menu of the Setup Utility. ● If a device is connected to the ExpressCard slot, disconnect the device, or set [ExpressCard Slot] to [Disabled] in the [Advanced] menu of the Setup Utility. ● Press Fn + F8 to turn off the concealed mode. ● Check the [UEFI Boot] setting of the Setup Utility. [UEFI Boot] should be set to Windows 8.1 [Enabled] / Windows 7 [Disabled].
<p>The power is turned on but "Warming up the system (up to 30 minutes)" appears.</p>	<ul style="list-style-type: none"> ● The computer is warming up before start up. Wait for the computer to start up (takes up to 30 minutes). If "Cannot warm up the system" is displayed, the computer failed to warm up and will not start. In this case, turn off the computer, leave it in an environment of 5 °C or higher temperature for about an hour, and then turn on the power again.
<p>After adding or changing the RAM module, the power is turned on but nothing is displayed on the screen.</p>	<ul style="list-style-type: none"> ● Turn off the computer and remove the RAM module, then confirm whether the RAM module has compliant to specification. When the RAM module has conformed to specification, install it again.
<p>The computer does not enter sleep mode while the screen saver is running. (The screen stays black.)</p>	<ul style="list-style-type: none"> ● Slide and hold the power switch for 4 seconds or longer to shut down the computer forcibly. (Data not saved will be lost.) Then disable the screen saver.
<p>You have forgotten the password.</p>	<ul style="list-style-type: none"> ● Supervisor Password or User Password: Contact Panasonic Technical Support. ● Administrator password: <ul style="list-style-type: none"> • If you have a password reset disk, you can reset the administrator password. Set the disk and enter any wrong password, then follow the on-screen instructions and set a new password. • If you do not have a password reset disk, reinstall (→ page 15) and set up Windows, and then set a new password.
<p>"Remove disks or other media. Press any key to restart" or a similar message appears.</p>	<ul style="list-style-type: none"> ● A floppy disk is in the drive (optional) and it does not contain system startup information. Remove the floppy disk and press any key. ● If a device is connected to the USB port, disconnect the device, or set [USB Port] or [Legacy USB Support] to [Disabled] in the [Advanced] menu of the Setup Utility. ● If a device is connected to the ExpressCard slot, disconnect the device, or set [ExpressCard Slot] to [Disabled] in the [Advanced] menu of the Setup Utility. ● If the problem persists after removing the disk, it may be a hard disk failure. Contact Panasonic Technical Support. ● Set [UEFI Boot] to [Disabled] in the [Boot] menu of the Setup Utility.
<p>Windows startup and operation is slow.</p>	<ul style="list-style-type: none"> ● Press F9 in the Setup Utility (→  Reference Manual "Setup Utility") to return the Setup Utility settings (excluding the passwords) to the default values. Start the Setup Utility and make the settings again. (Note that the processing speed depends on the application software, so this procedure may not make Windows faster.) ● If you installed a resident software after purchase, turn off the residence. Disable the pop-up menu and Input Panel Tab. <ol style="list-style-type: none"> ① Open the Input Panel, and click [Tools] - [Options] - [Opening]. ② Remove the check mark of [Show Input Panel sliding open from the tab] and click [OK].

Troubleshooting (Basic)



■ Starting Up

<p>The date and time are incorrect.</p>	<ul style="list-style-type: none"> ● Make the correct settings. <ol style="list-style-type: none"> ① Open the Control Panel. <ul style="list-style-type: none"> Windows 8.1 1. Perform either of the following procedures. <ul style="list-style-type: none"> • Right-click  at the bottom left corner of the Desktop screen. • Click  on the Start screen. 2. Click [Control Panel]. Windows 7 Click  (Start) - [Control Panel]. ② Click [Clock, Language, and Region] - [Date and Time]. <ul style="list-style-type: none"> ● If the problem persists, the internal clock battery may need to be replaced. Contact Panasonic Technical Support. ● When the computer is connected to LAN, check the date and time of the server. ● The 2100 A.D. or later year will not be correctly recognized on this computer.
<p>[Executing Battery Recalibration] screen appears.</p>	<ul style="list-style-type: none"> ● The Battery Recalibration was canceled before Windows was shut down last time. To start up Windows, turn off the computer by the power switch, and then turn on.
<p>[Enter Password] does not appear when resuming from sleep/hibernation.</p>	<ul style="list-style-type: none"> ● Select [Enabled] in [Password On Resume] in the [Security] menu of the Setup Utility (→  <i>Reference Manual</i> "Setup Utility"). ● The Windows password can be used instead of the password set in the Setup Utility. <ol style="list-style-type: none"> ① Add a password. <ul style="list-style-type: none"> Windows 8.1 1. Display "Charm" and click  - [Change PC settings] - [Accounts]. 2. Click [Sign-in options], and click [Add] under "Password". Windows 7 1. Click  (Start) - [Control Panel]. 2. Click [User Accounts and Family Safety] - [Add or remove user accounts]. ② Set up the following. <ul style="list-style-type: none"> Windows 8.1 1. Open the Control Panel, click [System and Security] - [Power Options] - [Require a password on wakeup]. 2. Add a check mark for [Require a password]. Windows 7 1. Click [Control Panel] - [System and Security] - [Power Option] - [Require a password when the computer wakes] and add a check mark for [Require a password].
<p>Cannot resume.</p>	<ul style="list-style-type: none"> ● One of the following operations may have been carried out. Slide the power switch turn on the computer. Data not saved will be lost. <ul style="list-style-type: none"> • In sleep mode, the AC adaptor or battery pack was disconnected, or a peripheral was connected or disconnected. • The power switch was slid for four seconds or longer to forcibly turn off the computer. ● An error may occur when the computer automatically enters the sleep or hibernation mode while the screensaver is active. In this case, turn off the screensaver or change the pattern of the screensaver.

■ Starting Up

<p>Other startup problems.</p>	<ul style="list-style-type: none"> ● Press F9 in the Setup Utility (→  Reference Manual “Setup Utility”) to return the Setup Utility settings (excluding the passwords) to the default values. Start the Setup Utility and make the settings again. ● Remove all peripheral devices. ● Check to see if there was a disk error. <ol style="list-style-type: none"> ① Remove all peripheral devices including an external display. ② Windows 8.1 Perform either of the following procedures. <ul style="list-style-type: none"> • Right-click  at the bottom left corner of the Desktop screen. • Click  on the Start screen. ③ Windows 7 Click  (Start) - [Computer]. ④ Click [File Explorer]. ⑤ Right-click Windows 8.1 [Windows (C:)] / Windows 7 [Local Disk (C:)], and click [Properties]. ⑥ Click [Tools] - Windows 8.1 [Check] / Windows 7 [Check Now...]. <ul style="list-style-type: none"> • A standard user needs to enter an administrator password. ⑦ Follow the on-screen instructions. ● Windows 7 Start the computer in Safe Mode and check the error details. When the [Panasonic] boot screen disappears*¹ at startup, press and hold F8 until the Windows Advanced Options Menu is displayed. Select the Safe Mode and press Enter. <p>*¹ When [Password on boot] is set to [Enabled] in the [Security] menu of the Setup Utility, [Enter Password] appears after the [Panasonic] boot screen disappears. As soon as you enter the password and press Enter, press and hold F8.</p>
--------------------------------	---



■ Entering Password

<p>Even after entering the password, password input screen is displayed again.</p>	<ul style="list-style-type: none"> ● The computer may be in ten-key mode. If the NumLk indicator  lights, press NumLk to disable the ten-key mode, and then input. ● The computer may be in Caps Lock mode. If the Caps Lock indicator  lights, press Caps Lock to disable the Caps Lock mode, and then input.
<p>Cannot log on to Windows. (“The user name or password is incorrect.” is displayed.)</p>	<ul style="list-style-type: none"> ● The user name (account name) includes the “@” mark. <ul style="list-style-type: none"> - If another user account name exists: Log on to Windows using another user account name, and delete the account name that includes “@”. Then create a new account name. - If no other account name exists: You need to reinstall Windows (→ page 15).

■ Shutting down



<p>Windows does not shut down.</p>	<ul style="list-style-type: none"> ● Remove the USB device and the ExpressCard. ● Wait 1 or 2 minutes. It is not a malfunction.
------------------------------------	---

■ Display

<p>No display.</p>	<ul style="list-style-type: none"> ● The external display is selected. Press Fn + F3 or  + P to switch the display. Windows 7 Wait until the display has been switched completely before pressing Fn + F3 or  + P again. ● Windows 8.1 Then click the display mode. ● When using an external display, <ul style="list-style-type: none"> • Check the cable connection. • Turn on the display. • Check the settings of external display. ● The display is turned off by the power-saving function. The screen returns to the original state when you operate keyboard, screen or touch pad. When operating the keyboard, press a key that does not affect the computer operation, such as Ctrl. ● The computer entered sleep or hibernation by the power-saving function. To resume, slide the power switch.
--------------------	---

Troubleshooting (Basic)

■ Display

The screen is dark.	<ul style="list-style-type: none"> ● The screen is darker when the AC adaptor is not connected. Press Fn + F2 and adjust the brightness. As you increase the brightness, battery consumption increases. You can separately set the brightness for when the AC adaptor is connected and when not connected. ● Press Fn + F8 to turn off the concealed mode.
The screen does not become bright even if pressing Fn + F2 .	<ul style="list-style-type: none"> ● The brightness is set low to avoid malfunction where surrounding temperature is high. Use it in an environment of between -10 °C and 50 °C.
The screen is disordered.	<ul style="list-style-type: none"> ● Changing the number of display colors and resolution may affect the screen. Restart the computer. ● Connecting/disconnecting an external display may affect the screen. Restart the computer. ● Resuming from sleep or hibernation may affect the screen of the external display. Restart the computer.
During Simultaneous display, one of the screens becomes disordered.	<ul style="list-style-type: none"> ● When using the Extended Desktop, use the same display colors for the external display as those used by the LCD. If you continue to experience problems, try changing the display. ● Simultaneous display cannot be used until Windows startup is complete (during Setup Utility, etc.).
The external display does not work normally.	<ul style="list-style-type: none"> ● If the external display does not support the power saving function, it may not work normally when the computer enters the power saving mode. Turn off the external display.
<Only for model with GPS> The pointer cannot be controlled properly.	<ul style="list-style-type: none"> ● Operate the following steps. <ol style="list-style-type: none"> ① Starting the Setup Utility Restart the computer and press F2 or Del while [Panasonic] boot screen is displayed. ② Set [GPS] to [Disable] in the sub-menu of [Serial and Parallel Port Settings] in the [Advanced] menu of the Setup Utility. ③ Press F10 and select [Yes] at the confirmation message, and press Enter. The computer will restart. ④ Log on to Windows as an administrator. ⑤ Windows 8.1 <ol style="list-style-type: none"> 1. Perform either of the following procedures. <ul style="list-style-type: none"> • Right-click  at the bottom left corner of the Desktop screen. • Click  on the Start screen. 2. Click [Run], input "c:\util\drivers\gps\GPS.reg" then click [OK]. ⑥ Windows 7 Click  (Start) and input "c:\util\drivers\gps\GPS.reg" in [Search programs and files], and press Enter. ⑦ Click [Yes], click [Yes], and click [OK]. Then restart the computer. ⑧ Press F2 while [Panasonic] boot screen is displayed. ⑨ Set [GPS] to [Enable] in the sub-menu of [Serial and Parallel Port Settings] in the [Advanced] menu. ⑩ Press F10 and select [Yes] at the confirmation message, and press Enter.

■ Touch Pad / Touchscreen (only for model with touchscreen)

The pointer does not work.	<ul style="list-style-type: none"> ● When using the external mouse, connect it correctly. ● Restart the computer using the keyboard. ● If the computer does not respond to keyboard commands, read "No response" (→ page 23).
Cannot input using the touch pad.	<ul style="list-style-type: none"> ● Set [Touch Pad] to [Enabled] in the [Main] menu of the Setup Utility. ● The drivers for some mice may disable the touch pad. Check your mouse's operating instructions.
<Only for model with touch screen> Cannot input using the touchscreen.	<ul style="list-style-type: none"> ● Set [Touchscreen Mode] to [Auto] or [Tablet] in the [Main] menu of the Setup Utility. ● Set [Touchscreen] to [Enabled] in the [Advanced] menu of the Setup Utility.



■ Touch Pad / Touchscreen (only for model with touchscreen)

Cannot point the correct position using the included stylus.	<ul style="list-style-type: none"> ● Perform the touchscreen calibration (→  <i>Reference Manual</i> “Screen Input Operation”).
<p>Windows 8.1 <Only for model with touchscreen> “Charm” does not always appear by finger operation.</p>	<ul style="list-style-type: none"> ● Flick toward the center of the screen from the right edge. ● Use the included pen.

■ On-screen Document

<p>Windows 7 The document of PDF format is not displayed.</p>	<ul style="list-style-type: none"> ● Install Adobe Reader. <ol style="list-style-type: none"> ① Log on to Windows as an administrator. ② Click  (Start) and input “c:\util\reader\en\Pinstall.bat” in [Search programs and files] then press Enter. ③ Update Adobe Reader to its latest version. If your computer is connected to the internet, start up Adobe Reader and click [Help] - [Check for Updates...].
--	---

■ Others

No response.	<ul style="list-style-type: none"> ● Press Ctrl+Shift+Esc to open Task Manager and close the software application that is not responding. ● An input screen (e.g., password input screen at startup) may be hidden behind another window. Press Alt+Tab to check. ● Slide the power switch for 4 seconds or longer to shut down the computer, and then slide the power switch to turn it on. If the application program does not work normally, uninstall and reinstall the program. To uninstall, <ol style="list-style-type: none"> ① Open the Control Panel. <p>Windows 8.1</p> <ol style="list-style-type: none"> 1. Perform either of the following procedures. <ul style="list-style-type: none"> • Right-click  at the bottom left corner of the Desktop screen. • Click  on the Start screen. 2. Click [Control Panel]. <p>Windows 7</p> Click  (Start) - [Control Panel]. ② Click [Program] - [Uninstall a program].
Cannot enter characters correctly.	<ul style="list-style-type: none"> ● Select the same language setting for Windows and the internal keyboard (→ page 9).

LIMITED USE LICENSE AGREEMENT

THE SOFTWARE PROGRAM(S) (“PROGRAMS”) FURNISHED WITH THIS PANASONIC PRODUCT (“PRODUCT”) ARE LICENSED ONLY TO THE END-USER (“YOU”), AND MAY BE USED BY YOU ONLY IN ACCORDANCE WITH THE LICENSE TERMS DESCRIBED BELOW. YOUR USE OF THE PROGRAMS SHALL BE CONCLUSIVELY DEEMED TO CONSTITUTE YOUR ACCEPTANCE OF THE TERMS OF THIS LICENSE.

Panasonic Corporation has developed or otherwise obtained the Programs and hereby licenses their use to you. You assume sole responsibility for the selection of the Product (including the associated Programs) to achieve your intended results, and for the installation, use and results obtained therefrom.

LICENSE

- A. Panasonic Corporation hereby grants you a personal, non-transferable and non-exclusive right and license to use the Programs in accordance with the terms and conditions stated in this Agreement. You acknowledge that you are receiving only a LIMITED LICENSE TO USE the Programs and related documentation and that you shall obtain no title, ownership nor any other rights in or to the Programs and related documentation nor in or to the algorithms, concepts, designs and ideas represented by or incorporated in the Programs and related documentation, all of which title, ownership and rights shall remain with Panasonic Corporation or its suppliers.
- B. You may use the Programs only on the single Product which was accompanied by the Programs.
- C. You and your employees and agents are required to protect the confidentiality of the Programs. You may not distribute or otherwise make the Programs or related documentation available to any third party, by time-sharing or otherwise, without the prior written consent of Panasonic Corporation.
- D. You may not copy or reproduce, or permit to be copied or reproduced, the Programs or related documentation for any purpose, except that you may make one (1) copy of the Programs for backup purposes only in support of your use of the Programs on the single Product which was accompanied by the Programs. You shall not modify, or attempt to modify, the Programs.
- E. You may transfer the Programs and license them to another party only in connection with your transfer of the single Product which was accompanied by the Programs to such other party. At the time of such a transfer, you must also transfer all copies, whether in printed or machine readable form, of every Program, and the related documentation, to the same party or destroy any such copies not so transferred.
- F. You may not remove any copyright, trademark or other notice or product identification from the Programs and you must reproduce and include any such notice or product identification on any copy of any Program.

YOU MAY NOT REVERSE ASSEMBLE, REVERSE COMPILE, OR MECHANICALLY OR ELECTRONICALLY TRACE THE PROGRAMS, OR ANY COPY THEREOF, IN WHOLE OR IN PART.

YOU MAY NOT USE, COPY, MODIFY, ALTER, OR TRANSFER THE PROGRAMS OR ANY COPY THEREOF, IN WHOLE OR IN PART, EXCEPT AS EXPRESSLY PROVIDED IN THE LICENSE.

IF YOU TRANSFER POSSESSION OF ANY COPY OF ANY PROGRAM TO ANOTHER PARTY, EXCEPT AS PERMITTED IN PARAGRAPH E ABOVE, YOUR LICENSE IS AUTOMATICALLY TERMINATED.

TERM

This license is effective only for so long as you own or lease the Product, unless earlier terminated. You may terminate this license at any time by destroying, at your expense, the Programs and related documentation together with all copies thereof in any form. This license will also terminate effective immediately upon occurrence of the conditions thereof set forth elsewhere in this Agreement, or if you fail to comply with any term or condition contained herein. Upon any such termination, you agree to destroy, at your expense, the Programs and related documentation together with all copies thereof in any form.

YOU ACKNOWLEDGE THAT YOU HAVE READ THIS AGREEMENT, UNDERSTAND IT AND AGREE TO BE BOUND BY ITS TERMS AND CONDITIONS. YOU FURTHER AGREE THAT IT IS THE COMPLETE AND EXCLUSIVE STATEMENT OF THE AGREEMENT BETWEEN US, WHICH SUPERSEDES ANY PROPOSAL OR PRIOR AGREEMENT, ORAL OR WRITTEN, AND ANY OTHER COMMUNICATIONS BETWEEN US, RELATING TO THE SUBJECT MATTER OF THIS AGREEMENT.

Specifications

This page provides the specifications for the basic model.
The model number is different according to the unit configuration.

- To check the model number:
Check the bottom of the computer or the box the computer came in at the time of purchase.
- To check CPU speed, memory size and the hard disk drive (HDD) size:
Run the Setup Utility (→  *Reference Manual* "Setup Utility") and select [Information] menu.
[Processor Speed]: CPU speed, [Memory Size]: Memory size, [Hard Disk]: Hard disk drive size

■ Main Specifications

CPU	Intel® Core™ i5-5300U Processor (3 MB ¹ cache, up to 2.9 GHz) with Intel® Turbo Boost Technology	
Video controller	Built-in Chip	
Main Memory ²	4 GB ¹ , DDR3L PC3-12800L (16 GB ¹ Max.)	
Storage	HDD (500 GB) ³ SSD (512 GB / 256 GB / 128 GB) ³ Windows 8.1 Approx. 20 GB ³ is used as a partition with HDD recovery tools. (Users cannot use this partition.) Approx. 1 GB ³ is used as a partition with system tools. (Users cannot use this partition.) Windows 7 Approx. 50 GB ³ is used as a partition with HDD recovery tools. (Users cannot use this partition.) Approx. 300 MB ³ is used as a partition with system tools. (Users cannot use this partition.)	
Display Method	13.1 XGA type (TFT) (1024 × 768 dots)	
	Internal LCD	65,536 / 16,777,216 colors (800 × 600 dots / 1024 × 768 dots) ⁴
	External Display ⁵	65,536 / 16,777,216 colors (800 × 600 dots / 1024 × 768 dots / 1280 × 768 dots / 1280 × 1024 dots)
Wireless LAN ⁶	Intel® Dual Band Wireless-AC 7265 (a/b/g/n/ac) (→ page 26)	
Bluetooth ⁷	→ page 26	
Wireless WAN ⁸	Sierra Wireless™ High-speed module	
GPS ⁹	Chip: u-blox M8 Accuracy: 4.8 m (2DRMS) Protocol message: GPS/GLONASS/SBAS Support	
LAN	IEEE 802.3 10Base-T / IEEE 802.3u 100BASE-TX / IEEE 802.3ab 1000BASE-T (2nd LAN ¹⁰ : IEEE 802.3 10BASE-T, IEEE 802.3u 100BASE-TX, IEEE 802.3ab 1000BASE-T)	
Sound	WAVE and MIDI playback, Intel® High Definition Audio subsystem support	
Security Chip	TPM (TCG V1.2 compliant) ¹¹	
Card Slots	PC Card Slot	× 1, Type I or Type II, Allowable current 3.3 V: 400 mA, 5 V: 400 mA
	ExpressCard Slot ¹²	× 1, ExpressCard/34 or ExpressCard/54
	SD Memory Card Slot ¹³	× 1
	Contact Smart Card Slot ¹⁴	× 1
RAM Module Slot	× 1, DDR3L SDRAM, 204-pin, 1.35 V, SO-DIMM, PC3-12800 Compliant	
Interface	USB Ports x 4 ¹⁵ (USB 2.0 × 3 + USB 3.0 × 1) / Serial Port (Dsub 9-pin male) / LAN Port (RJ-45) × 1 ¹⁶ or 2 ¹⁰ / VGA Port (Mini Dsub 15-pin female) / HDMI Port (Type A) ¹⁷ / IEEE1394a Interface Connector (4-pin) ¹⁸ / Microphone Jack (Miniature jack, 3.5 DIA) / Headphone Jack (Miniature jack, 3.5 DIA, Impedance 32 Ω, Output Power 4 mW × 2, Stereo) / Expansion Bus Connector (Dedicated 80-pin female)	
Keyboard / Pointing Device	88 or 87 keys / Touch Pad / Touchscreen ¹⁹	
Fingerprint Reader ²⁰	Image Size : 200 x 400 pixels , Image Resolution : 508 DPI	
Camera ²¹	1280 × 720 dots, 30 fps (Video), Monaural Microphone	
Power Supply	AC adaptor or Battery pack	
AC Adaptor ²²	Input: 100 V - 240 V AC, 50 Hz/60 Hz, Output: 15.6 V DC, 7.05 A	

Specifications

■ Main Specifications

Battery Pack		Li-ion 10.65 V, Typical 8550 mAh / Minimum 8100 mAh	
Operating Time ^{*23}		Main Battery : Approx. 18.0 hours Main Battery + Second Battery ^{*24} : Approx. 27.0 hours	
Charging Time ^{*25}	Power on	Main Battery : Approx. 3.5 hours Main Battery + Second Battery ^{*24} : Approx. 7.0 hours	
	Power off	Main Battery : Approx. 3.5 hours Main Battery + Second Battery ^{*24} : Approx. 7.0 hours	
Power Consumption ^{*26}		Approx. 40 W ^{*27} / Approx. 80 W (maximum when recharging in the ON state)	
Physical Dimensions (W × D × H) (including the carrying handle)		302 mm × 292 mm × 73.5 mm	
Weight (including the hand strap)		Approx. 3.72 kg	
Environment	Operating	Temperature	-10 °C to 50 °C (IEC60068-2-1, 2) ^{*28}
		Humidity	30 % to 80 % RH (No condensation)
	Storage	Temperature	-20 °C to 60 °C
		Humidity	30 % to 90 % RH (No condensation)

■ Software

Base OS		Windows® 8.1 Pro Update 64-bit
Installed OS ^{*29}		Windows 8.1 Windows® 8.1 Pro Update 64-bit Windows 7 Windows® 7 Professional 32-bit Service Pack 1 (downgraded to Windows® 7) ^{*30} / Windows® 7 Professional 64-bit Service Pack 1 (downgraded to Windows® 7) ^{*30}
Pre-installed Software		Adobe Reader, PC Information Viewer, Intel® PROSet/Wireless Software [®] , Intel® PROSet/Wireless Software for Bluetooth® Technology ⁷ , Hotkey Settings, Battery Recalibration Utility, Infineon TPM Professional Package ^{*11 *31} , Aptio Setup Utility, PC-Diagnostic Utility, Display Selector, Hard Disk Data Erase Utility ^{*32} , Recovery Disc Creation Utility, Dashboard for Panasonic PC, Power Plan Extension Utility, Camera Utility ^{*21} , GPS Viewer [®] , Manual Selector, Fan Monitoring Utility, Microsoft Office Trial ^{*33} , Intel® WiDi, Intel® My WiFi Technology, EVE FA Standalone for Panasonic ^{*20 *31} , Hand Writing Utility, Wireless antenna switch utility Windows 8.1 Wireless Toolbox Windows 7 Wireless Switch Utility, Wireless Connection Disable Utility ^{*6 *8 *31} , Quick Boot Manager

■ Wireless LAN^{*6}

Data Transfer Rates	IEEE802.11a : 54 Mbps IEEE802.11b : 11 Mbps IEEE802.11g : 54 Mbps IEEE802.11n : HT20 : 150 Mbps HT40 : 300 Mbps IEEE802.11ac : VHT80 : 866.7 Mbps VHT40 : 433.3 Mbps
Standard Supported	IEEE802.11a / IEEE802.11b / IEEE802.11g / IEEE802.11n / IEEE802.11ac
Transmission Method	OFDM system, DSSS system

■ Bluetooth® *7

Bluetooth Version	4.0
	Classic mode / Low Energy mode
Transmission Method	FHSS system
Wireless Channels Used	Channel 1 to 79 / Channel 0 to 39
RF Frequency Band	2.402 GHz - 2.480 GHz

- *1 1 MB = 1,048,576 bytes / 1 GB = 1,073,741,824 bytes
- *2 Memory size of the factory default depends on the model. You can physically expand the memory up to 8 GB, but the total amount of usable memory available will be less depending on the actual system configuration.
- *3 1 MB = 1,000,000 bytes / 1 GB = 1,000,000,000 bytes. Your operating system or some application software will report as fewer GB.
- *4 A 16,777,216 color display is achieved by using the dithering function.
- *5 Display may be impossible using some connected external displays.
- *6 Only for model with wireless LAN.
- *7 Does not guarantee operation of all Bluetooth peripherals.
- *8 Only for model with wireless WAN. The specifications may differ depending on the model.
A SIM card (15 mm x 25 mm) must be inserted in the SIM card slot.

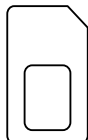

- *9 Only for model with GPS.
- *10 Only for model with 2nd LAN.
- *11 Only for model with TPM.
For information on TPM, refer to the Installation Manual of "Trusted Platform Module (TPM)" by the following procedure.
Double-click [Manual Selector] on the desktop, and select "Installation Manual for Trusted Platform Module (TPM)".
- *12 Only for model with ExpressCard slot.
- *13 This slot is compatible with High-Speed Mode. Operation has been tested and confirmed using Panasonic SD/SDHC/SDXC Memory Cards with a capacity of up to 64 GB. Operation on other SD equipment is not guaranteed.
- *14 Only for model with Smart Card slot.
- *15 Does not guarantee operation of all USB-compatible peripherals.
- *16 Only for model without 2nd LAN.
- *17 Does not guarantee operation of all HDMI-compatible peripherals.
- *18 Only for model with IEEE 1394a interface.
- *19 Only for model with Touchscreen.
- *20 Only for model with Fingerprint reader.
- *21 Only for model with Camera. The specifications may differ depending on the model.
- *22 <Only for North America>
The AC adaptor is compatible with power sources up to 240 V AC adaptor. This computer is supplied with a 125 V AC compatible AC cord. 20-M-2-1
- *23 Measured with LCD brightness : 60 cd/m²
Varies depending on the usage conditions, or when an optional device is attached.
- *24 Only for model with Second Battery.
- *25 Varies depending on the usage conditions, CPU speed, etc.
- *26 Approx. 0.5 W when the battery pack is fully charged (or not being charged) and the computer is off.
<When using with 115 V AC>
Even when the AC adaptor is not connected to the computer, power is consumed (Max. 0.2 W) simply by having the AC adaptor plugged into an AC outlet.
<When using with 240 V AC>
Even when the AC adaptor is not connected to the computer, power is consumed (Max. 0.3 W) simply by having the AC adaptor plugged into an AC outlet.
- *27 Rated power consumption. 23-E-1
- *28 Do not expose the skin to this product when using the product in a hot or cold environment. (➔ OPERATING INSTRUCTIONS - Read Me First)
When using in hot or cold environment, some peripherals may fail to work properly. Check the operation environment of the peripherals.
Using this product continuously in a hot environment will shorten the product life. Avoid use in these types of environments.
When using in low temperature environment, startup may become slow or battery operation time may become short.
The computer consumes power when the hard disk is warming up during startup. Therefore, if you are using battery power and the remaining power is low, the computer may not start up.
- *29 Operations of this computer are not guaranteed except for the pre-installed OS and the OS which is installed by using the Recovery disc provided by Panasonic.
- *30 This system is preinstalled with Windows® 7 Professional software and also comes with a license for Windows 8.1 Pro software. You may only use one version of the Windows software at a time. Switching between versions will require you to uninstall one version and install the other version.
- *31 Must be installed before use.
- *32 Perform on the recovery disc.
Windows 7
Alternatively perform on the hard disk recovery partition.
- *33 To continue using this software after the end of the trial, purchase a license by following the on-screen instructions.

Standard Limited Warranty

Panasonic System Communications Company Europe

Panasonic System Communications Company Europe (referred to as "Panasonic") will repair this product (other than software, which is treated in a different section of this warranty) with new or refurbished parts, from the date of original purchase in the event of a defect in materials or workmanship. This warranty only applies to new Panasonic Toughbooks purchased in the EEA and Switzerland and Turkey.

Panasonic (or its authorised Service Provider) target to repair your equipment within 48 hours from its receipt in our service centre.

Additional charges may apply for shipment to countries outside of the European Union. Panasonic will use all reasonable endeavours to ensure this service.

This warranty only covers failures due to defects in materials or workmanship which occur during normal use for the applicable Service Agreement Period listed below. In the event that any product (or part thereof) is replaced, Panasonic shall transfer ownership of the replacement product (or part) to the customer and the customer shall transfer ownership of the replaced product (or part) to Panasonic.

Service Agreement Period - from original date of purchase

- Toughbooks (and every accessory included in the original packaging except the battery) - 3 years
- Toughpads (and every accessory included in the original packaging except the battery) - 3 years
- Accessories included in the original package - 3 years
- Additional peripherals manufactured by Panasonic (including media bay devices such as CD-Rom drives) - 1 year
- Batteries - 6 months. Panasonic Warranty covers the battery for six months. A battery is considered good if it maintains 50% of its charge capacity during the warranty period. If a battery is returned under this contract and testing determines that it has charge capacity greater than 50%, the battery will be returned with an invoice for the retail purchase price of a new battery.

This warranty is extended solely to the original purchaser. A purchase receipt or other proof of date of original purchase will be required before warranty performance is rendered.

Limits and Exclusions:

This warranty does not cover and shall be void for:

- Broken or cracked LCD screen.
- Defective pixel in notebook displays and LCD screens within 0.002%
- Damage that is attributable to fire, theft or acts of God.
- Damage caused by environmental influences (electrical storms, magnetic fields etc.).
- Damage which has not been caused during normal operation
- Repair of damage that is cosmetic only or does not affect product functionality such as wear and tear, scratches and dents.
- Failures caused by products not supplied by Panasonic.
- Failures resulting from alteration, accidental damage, casualty, misuse, abuse or neglect.
- Introduction of liquid or other foreign matter into the unit.
- Improper installation, operation or maintenance.
- Improper connections with peripherals.
- Maladjustment of consumer controls such as function settings.
- Modification or service by anyone other than Panasonic or its approved Service Providers.
- Products used as short term rental or leased equipment.
- Products whose serial number has been removed making the unit warranty condition impossible to clearly determine.

THIS PRODUCT IS NOT INTENDED FOR USE AS, OR AS PART OF, NUCLEAR EQUIPMENT/SYSTEMS, AIR TRAFFIC CONTROL EQUIPMENT/SYSTEMS, OR AIRCRAFT COCKPIT EQUIPMENT/SYSTEMS. PANASONIC WILL NOT BE RESPONSIBLE FOR ANY LIABILITY RESULTING FROM THE USE OF THIS PRODUCT ARISING OUT OF THE FOREGOING USES.

There are no other express warranties except as listed above.

We strongly recommend that customers backup their data before sending back their unit to an Authorised Service Provider.

Panasonic shall not be liable for loss of data or other incidental or consequential damages resulting from the use of this product, or arising out of any breach of this warranty. All express and implied warranties, including the warranties of satisfactory quality and fitness for a particular purpose are limited to the applicable warranty period set forth above. Panasonic shall not be liable for any indirect, special or consequential loss or damage (including without limitation any loss of profits) arising from the use of this product or for any breach of this warranty.

This limited warranty gives you specific legal rights, and you may have other rights that vary from country to country. You must consult the applicable country laws for a full determination of your rights. This limited warranty is in addition to, and does not affect any rights arising out of any contract of sale or by statute.

Panasonic System Communications Company Europe

Data Storage Media

Data Storage Media is the media on which the Operating System, drivers and programs originally installed by Panasonic on the main unit are stored. This media is originally provided with the unit.

Panasonic warrants to you only that the disc(s) or other media on which the Programs are furnished will be free from defects in material and workmanship under normal use for a period of sixty (60) days from the date of delivery thereof to you, as evidenced by your purchase receipt.

This is the only warranty Panasonic makes to you. Panasonic does not warrant that the functions contained in the Programs will meet your requirements or that the operation of the Programs will be uninterrupted or error free.

Panasonic's entire liability and your exclusive remedy under this warranty shall be limited to the replacement of any defective disk or other media which is returned to Panasonic's authorized Service Centre, together with a copy of the purchase receipt, within the aforesaid warranty period.

Panasonic shall have no obligation for any defects in the disk(s) or other media on which the Programs are furnished resulting from your storage thereof, or for defects that have been caused by operation of the disk(s) or other media otherwise than on the Product or in the environment conditions other than those specified by Panasonic by alteration, accident, misuse, abuse, neglect, mishandling, misapplication, installation, maladjustment of consumer controls, improper maintenance, modification or damage that is attributable to acts of God. In addition, Panasonic shall have no obligation for any defects in the disk(s) or other media if you have modified, or attempted to modify any Program.

Duration of implied warranties, if any is limited to sixty (60) days.

Pre-installed software

Pre-installed software means the software shipped pre-loaded by Panasonic, not that loaded by any third party or selling agent.

Panasonic and its suppliers makes no warranty, either express, implied or statutory, with respect to software provided with the Product and licensed to Purchaser, its quality, performance, merchantability, or fitness for a particular purpose. Panasonic does not warrant that the functions contained in the software will be uninterrupted or error free. Panasonic assumes no risk of and shall not in any case be liable for any damages, including, without limitation, any special, incidental, consequential, or punitive damages arising from breach of warranty or contract, negligence or any other legal theory, including, without limitation loss of goodwill, profits or revenue, loss of use of the Programs or Products or any associated equipment, cost of capital, cost of any substitute equipment, facilities, or services, downtime costs, or claims of any party dealing with such damages.

Some countries do not allow the exclusion or limitation of incidental or consequential damages, or limitations on how long an implied warranty lasts, so the above limitations or exclusions may not apply to you.

This limited warranty gives you specific legal rights and you may also have other rights that vary from country to country. You must consult applicable country laws for a full determination of your rights.

Contacts

Address

Panasonic System Communications Company Europe
Panasonic Manufacturing U.K. Ltd.
Service Centre Building B4,
Wharfedale Road, Pentwyn Industrial Estate, Cardiff,
United Kingdom
CF23 7XB

Web page

<http://www.toughbook.eu/>

Helpdesk

English speaking service
French speaking service
German speaking service
Italian speaking service
Spanish speaking service
Austria
Switzerland (German)
Switzerland (French)
E-mail address

+44 (0) 800 0884324
+33 (0) 80 5636449
+49 (0) 800 7235211
+39 800 986915
+34 (0) 901 101 157
+43 (0) 800 006493
+41 (0) 800 002429
+41 (0) 800 588017
toughbooksupport@eu.panasonic.com

Czech speaking service
Hungarian speaking service
Polish speaking service
Romanian speaking service
Slovakian speaking service
E-mail address

+420 (0) 800 143234
+36 (0) 6800 163 67
+48 (0) 800 4911558
+40 (0) 800 894 743
+421 (0) 800 42672627
toughbooksupport@csg.de

Payments

toughbookservicepayments.cardiff@eu.panasonic.com



As an ENERGY STAR® Partner, Panasonic Corporation has determined that this product meets ENERGY STAR® guidelines for energy efficiency. By enabling available power management settings, Panasonic computers enter a low-power sleep mode after a period of inactivity, saving the user energy.

Outline of the International ENERGY STAR® Office Equipment Program

The international ENERGY STAR® Office Equipment Program is an international program that promotes energy saving through the use of computers and other office equipment. The program backs the development and dissemination of products with functions that effectively reduce energy consumption. It is an open system in which business proprietors can participate voluntarily. The targeted products are office equipment such as computers, displays, printers, facsimiles, and copiers. Their standards and logos are uniform among participating nations.

22-E-1

Panasonic Corporation
Osaka, Japan

Importer's name & address pursuant to the EU legislation.

Panasonic System Communications Company Europe, Panasonic Marketing Europe GmbH
Hagenauer Straße 43
65203 Wiesbaden
Germany

55-E-1